

Features

- 33" (838 mm) minimum base cabinet width for top-mount installation.
- 36" (914 mm) minimum base cabinet width for undermount installation.
- Large/medium bowls.
- 9" (229 mm) depth provides generous workspace.
- Smart Divide® feature offers a lower bowl divider that increases workspace versatility.
- Versatile design allows large basin to be installed on the right or left.

Material

- KOHLER® enameled cast iron.

Installation

- Top-mount or undermount.

Recommended Products/Accessories

- K-5137 Sink Rack
- K-5139 Sink rack
- K-23726 Drain treatment
- K-23725 Cast iron cleaner
- 1411886 Undermount sink kit 23"

Optional Products/Accessories

- K-11352 Disposal Flange with Stopper
- K-9000 P-Trap



Codes/Standards















ASME A112.19.1/CSA B45.2

KOHLER® Enameled Cast Iron Kitchen Sink Lifetime Limited Warranty

See website for detailed warranty information.

Available Colors/Finishes

Color tiles intended for reference only.

| Color | Code | Description |
|-------------------------------------------------------------------------------------|------|-----------------|
|  | 0 | White |
|  | FF | Sea Salt™ |
|  | 96 | Biscuit |
|  | NY | Dune |
|  | FE | Frost |
|  | 95 | Ice™ Grey |
|  | G9 | Sandbar |
|  | K4 | Cashmere |
|  | FT | Basalt |
|  | 58 | Thunder™ Grey |
|  | R1 | Roussillon™ Red |
|  | FP | Caviar |
|  | 7 | Black Black™ |
|  | GRL | Grey Lavender |
|  | DGB | Indigo Blue |
|  | PLM | Black Plum |

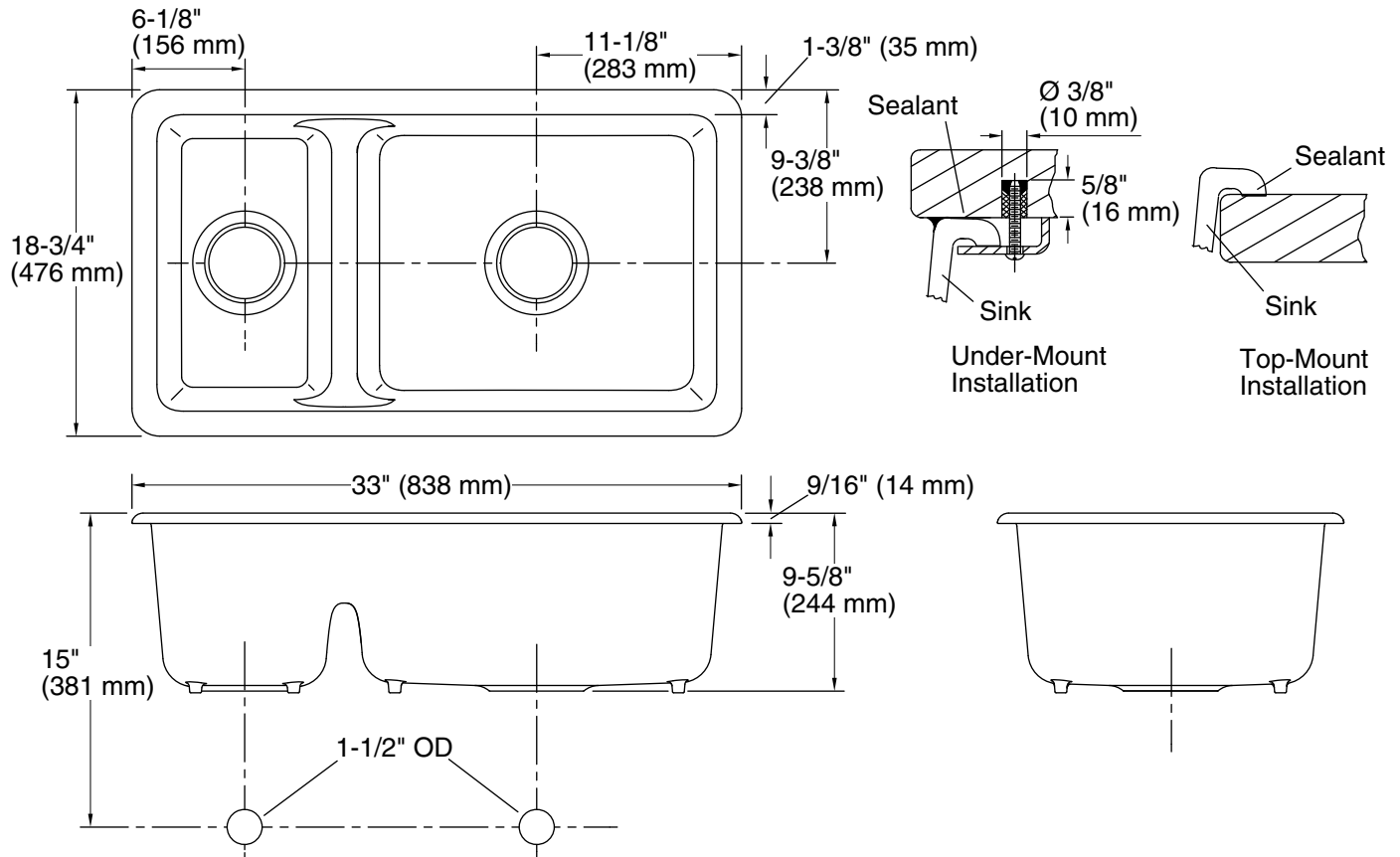

Technical Information

All product dimensions are nominal.

| | |
|--------------------------|-----------------------------------------------------------------------------|
| Bowl configuration: | Off-set Large/small |
| Installation: | Top-mount, Undermount |
| Min. base cabinet width: | 36" (914 mm) |
| Bowl area (Right): | Length: 19-1/4" (489 mm) Width: 16" (406 mm) Water depth: 9" (229 mm) |
| Bowl area (Left): | Length: 9-1/4" (235 mm) Width: 16" (406 mm) Water depth: 9" (229 mm) |
| Drain hole: | 3-7/8" (98 mm) |
| Template: | 1043168-7, required, included |

Notes

Install this product according to the installation instructions.

NOTICE: The countertop manufacturer or cutter must use the cut-out template provided with the product, or a current one provided by the Kohler Co. (Call 1-800-4-KOHLER.) Kohler Co. is not responsible for cut-out errors when the incorrect cut-out template is used.