

B3Square 6036 Acrylic Configurable Shower Base

Model number:

420006-501-001-102

Dimensions: 59.875" x 35.875" x 3"

Installation:

Material: Acrylic

Standard Features:

- Acrylic rectangular shower base with square drain
- Low 3 in. threshold base allowing an easy and safe access
- Certain configurations available with Stabili-T anti-slip bottom meeting ADA, ANSI or CSA



- Chrome grid and drain included (ABS or PVC available)
- Compatible with Utile, most glue-up shower walls and ceramic tiles

Product characteristics:

- Low Threshold
- Utile Compatible
- Bestseller

Standard Colors:



White

Certifications

MAAX products adhere to one or more of the following certifications:



MAAX

B3Square 6036 Acrylic Configurable Shower Base

Model number:

420006-501-001-102

Dimensions: 59.875" x 35.875" x 3"

Installation:

Material: Acrylic

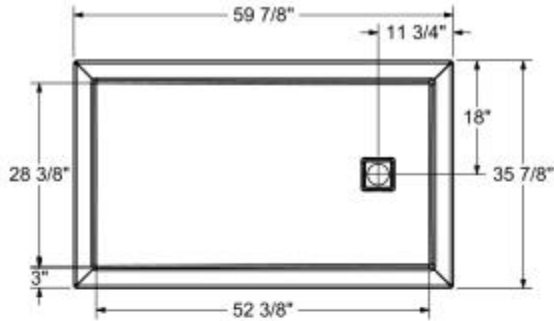

DRAIN INCLUDED
ON B3 SQUARE ONLY

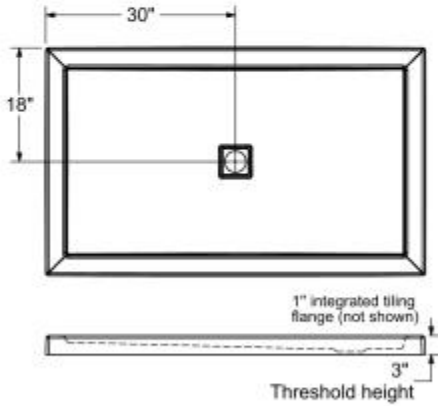

This technical drawing is universal for every 6036 configuration.

Integrated tiling flange : 1" height x 1/4" thick (not shown)
Tiling flange position is determined by chosen configuration.

All dimensions are approximate. Structure measurements
must be verified against the unit to ensure proper fit.

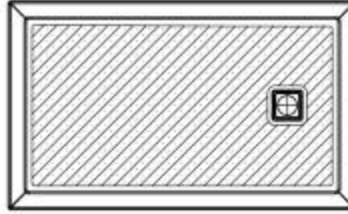

The hatched area represent the anti-slip surface

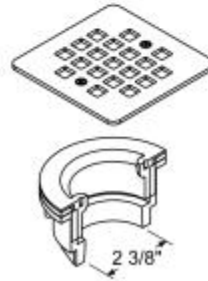
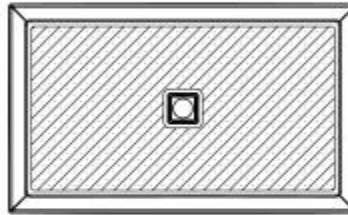

Dimensions

60 x 36 x 3 In.
(1521 x 911 x 76 mm)

Weight

62 lbs - 28 kg

Shape

Rectangular

Drain location:

Center

Back End

Left

Right

Project:

Contractor:

Representative:

Date:

Tel:

Notes:

MAAX