

# Location:



3601-TRM, 3601TRMTC  
Shower Trim  
**Specification Submittal**



## Feature Highlights

- Duro Shower Trim
- Requires Temptrol® Pressure Balancing Shower Valve
- Metal lever handle
- 1 mode showerhead
- Standard flow rate 2.0 gpm (7.6 L/min) flow restrictors
- Tub spout not included
- Components shall be metal and nonmetallic construction, plated in standard Polished Chrome finish
- Available with TA-10 flow control spindle and T-12A cap assembly for Temptrol valve bodies installed with Test Cap (order p/n 3601TRMTC)

## Model Numbers

- 3601-TRM**  
Shower Trim, Temptrol Pressure Balancing Shower Valve ordered separately
- 3601TRMTC**  
Shower Trim with TA-10 flow control spindle and T-12A cap assembly, must order Temptrol valve with Test Cap

## Options/Modifications

- 1.5**  **1.5 gpm (5.7 L/min) flow restrictor**
- L1** **Less showerhead**
- L4** **Less head, arm and flange**
- L7** **Less handle**
- SH4** **Square, 1 mode showerhead**
- BBZ** **Brushed Bronze finish**
- MB** **Matte Black finish**
- STN** **Satin Nickel finish**

**Note:** Append appropriate -suffix to model number.

## Compliance

- ASME A112.18.1/CSA B125.1
- WaterSense 1.5 gpm (5.7 L/min) 2.0 gpm (7.6 L/min)



## Warranty

**Limited Lifetime** - to the original end purchaser in consumer/residential installations.  
**10 Years** - for commercial/industrial installations. Refer to [www.symmons.com/warranty](http://www.symmons.com/warranty) for complete warranty information.



## Architectural/Engineering Specification

Symmons Duro Shower Trim \_\_\_\_\_ Includes Duro Shower Trim, Requires Temptrol® Pressure Balancing Shower Valve, Metal lever handle, 1 mode showerhead, Standard flow rate 2.0 gpm (7.6 L/min) flow restrictors, Tub spout not included, Components shall be metal and nonmetallic construction, plated in standard Polished Chrome finish, Available with TA-10 flow control spindle and T-12A cap assembly for Temptrol valve bodies installed with Test Cap (order p/n 3601TRMTC). 10 Year Commercial Warranty. ASME A112.18.1/CSA B125.1, WaterSense 1.5 gpm (5.7 L/min), 2.0 gpm (7.6 L/min) compliant. Available options: "1.5 - 1.5 gpm (5.7 L/min) flow restrictor", "Delete Suffix B - Chrome plastic escutcheon on valve with color graphics/indicators in place of standard brass escutcheon", "SH4 - Square, 1 mode showerhead", "T4 - Square, non-diverter tub spout", "TRM - Trim only, valve not included", "L1 - Less showerhead", "L2 - Less hand shower (wand only)", "L3 - Less showerhead and hand shower (head and wand only)", "L4 - Less head, arm and flange", "L5 - Less hand shower system (less bar/cradle, hose, wand and elbow)", "L6 - Less tub spout", "L7 - Less handle", "BBZ - Brushed Bronze finish", "MB - Matte Black finish", "STN - Satin Nickel finish".

# Dimensions

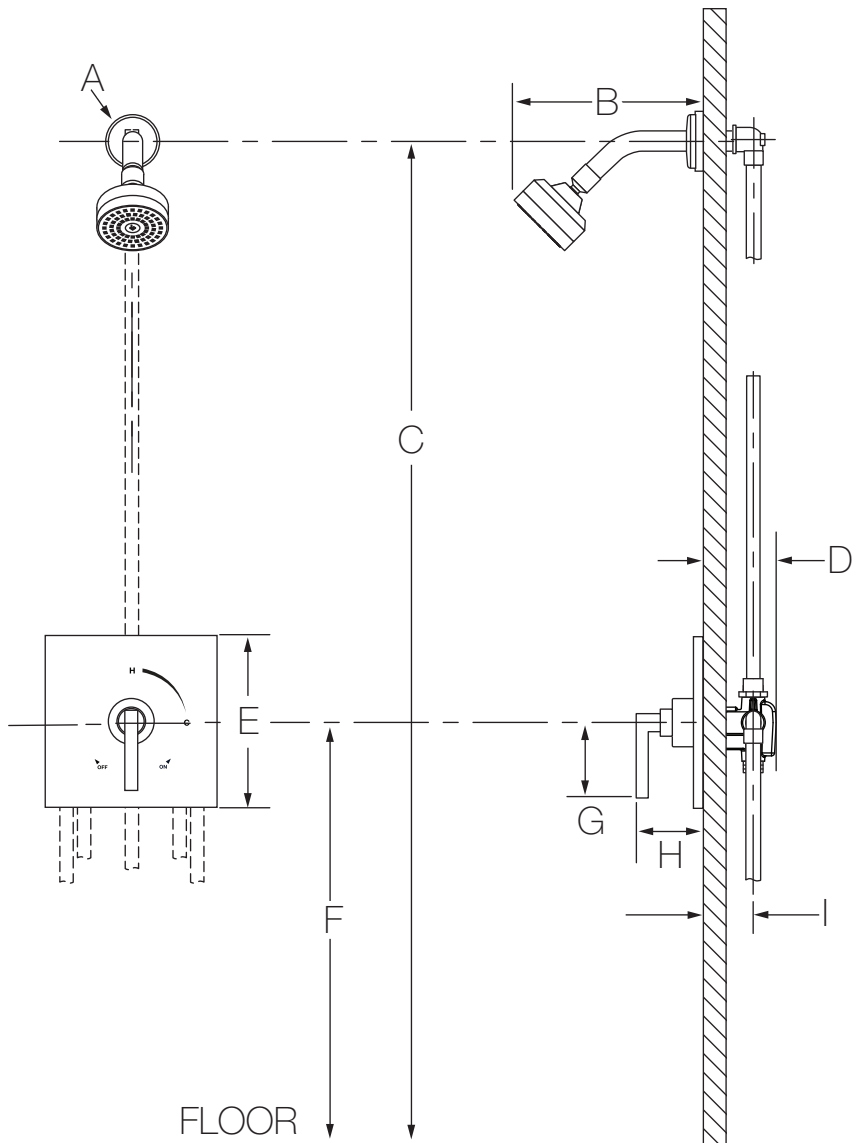

Measurements	
<b>A</b>	Ø 2-1/2", 64 mm
<b>B</b>	6", 152 mm
<b>C</b>	Ref. 77", 1956 mm
<b>D</b>	3-1/2", 89 mm
<b>E</b>	Sq. 7-1/2", 191 mm
<b>F</b>	Ref. 42", 1067 mm
<b>G</b>	3-1/8", 79 mm
<b>H</b>	3-1/2", 89 mm
<b>I</b>	Rough-in 2-3/8" ± 1/2", 60 mm ± 13 mm
<b>J</b>	6-3/4", 171 mm
<b>K</b>	6-3/4", 171 mm
<b>L</b>	5-5/8", 143 mm
<b>S</b>	6-3/4", 171 mm
<b>T</b>	6", 152 mm
<b>U</b>	5-5/8", 143 mm
<b>V</b>	3", 76 mm
<b>W</b>	2-7/8", 73 mm
<b>X</b>	1-3/8", 35 mm
<b>Y</b>	2-7/8", 73 mm
<b>Z</b>	2-1/4", 57 mm
<b>AA</b>	2-3/4", 70 mm
<b>BB</b>	6", 152 mm
<b>CC</b>	Female 1/2-14 NPT fitting must be recessed 3/8" (10 mm) from finished wall

**-SH2**

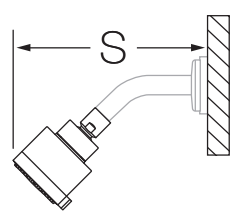

**-SH3**

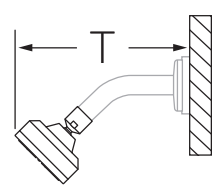

**-SH4**

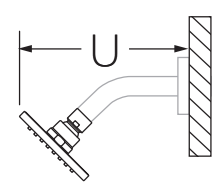
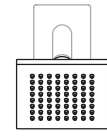

**-D2**

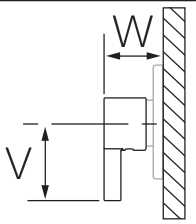

**-D3**

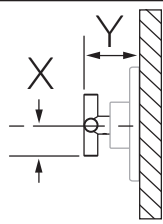

**-T4**

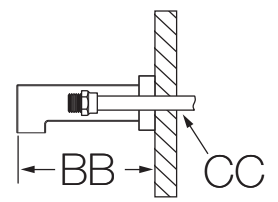
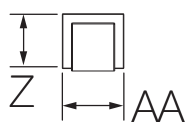

**Notes:**

- 1) Valve body and piping not included and shown as reference only.
- 2) Plaster shield (p/n T-176) for dry wall, plaster or other type walls 1/2" or greater.
- 3) All dimensions measured from nominal rough-in (see I as reference).
- 4) Dimensions subject to change without notice.