

Features

- 21" (533 mm) minimum base cabinet width.
- Single round bowl.
- 8" (203 mm) depth.

Material

- KOHLER® enameled cast iron.

Installation

- Top-mount or undermount.

Recommended Products/Accessories

- K-8801 Sink drain and strainer with tailpiece
- K-8799 Sink drain and strainer basket
- K-23726 Drain treatment
- K-23725 Cast iron cleaner

Optional Products/Accessories

- K-11352 Disposal Flange with Stopper

Included Components

Product consists of:

- 52047 Clamp Accessory Pack, 4 Ea.



ADA

Codes/Standards













ASME A112.19.1/CSA B45.2
ADA
ICC/ANSI A117.1

KOHLER® Enameled Cast Iron Kitchen Sink Lifetime Limited Warranty

See website for detailed warranty information.

Available Colors/Finishes

Color tiles intended for reference only.

Color	Code	Description
	0	White
	FF	Sea Salt™
	96	Biscuit
	FD	Cane Sugar™
	NY	Dune
	95	Ice™ Grey
	G9	Sandbar
	K4	Cashmere
	FT	Basalt
	58	Thunder™ Grey
	FP	Caviar
	7	Black Black™
	97	Timberline™

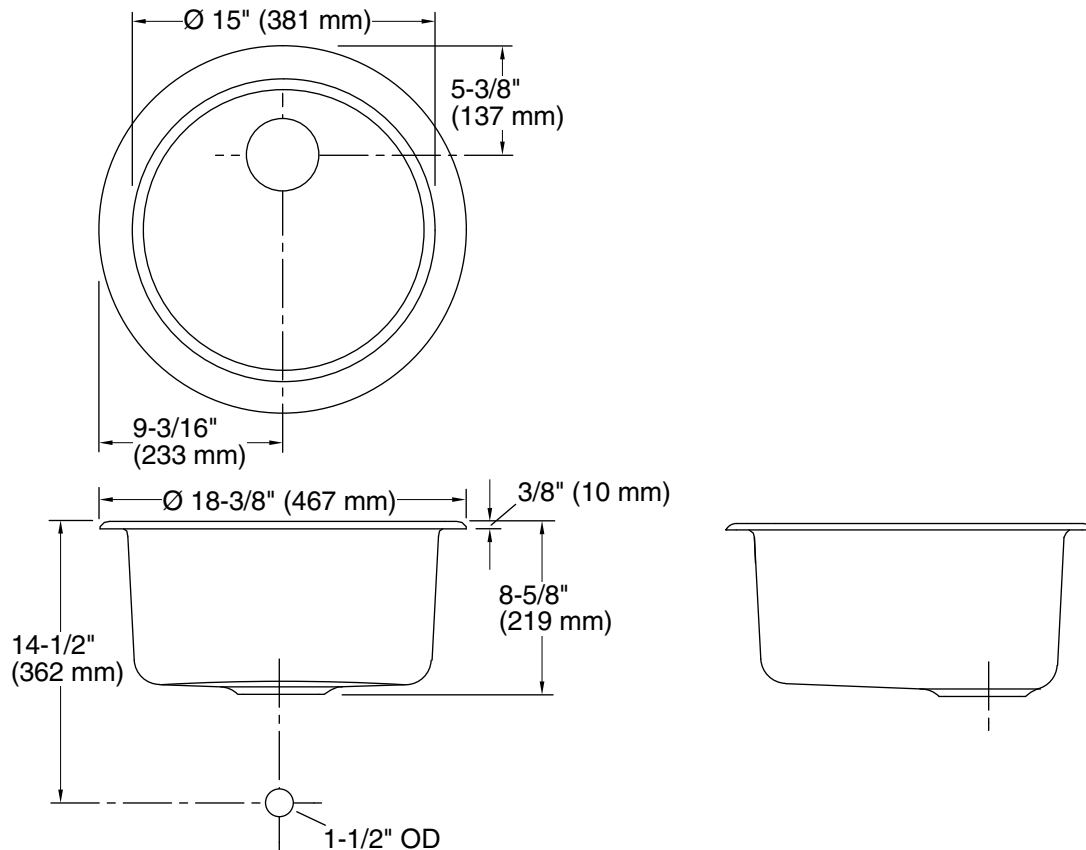

Technical Information

All product dimensions are nominal.

- Bowl configuration: Single
- Installation: Top-mount, Under-mount
- Min. base cabinet width: 21" (533 mm)
- Bowl area (Only): Length: 15" (381 mm)
 Width: 15" (381 mm)
 Bowl depth: 8" (203 mm)
- Drain hole: 3-5/8" (92 mm)
- Template: 112355-7, required, included

Notes

- Install this product according to the installation instructions.
- ADA compliant when installed to the specific requirements of these regulations.
- ADA permits a parallel approach to wet bars.