

Location:



SYMMONS® Origins ActivSense™



Includes 4" deck plate

S6960B & S6960E

Sensor Lavatory Faucet

Specification Submittal

Model Numbers	Feature Highlights
<input type="checkbox"/> S6960B <i>Single Supply Sensor Lavatory Faucet 6X1.5V Batteries included</i> <input type="checkbox"/> S6960E <i>Single Supply Sensor Lavatory Faucet 9V Transformer</i>	<ul style="list-style-type: none"> • LEED Rating • Hygiene flush • Solid brass body • Adjustable settings • ADA compliant • Single hole or 4" center, optional deck plate included • Power source is interchangeable with 6 AA batteries • 0.5 gpm (1.9 L/min) flow rate standard
Finish Options/Modifications	Compliance
<input type="checkbox"/> STS <i>Stainless Steel finish</i> <input type="checkbox"/> 035 <i>0.35 gpm (1.3 L/min) flow restrictor</i> <input type="checkbox"/> 10 <i>1.0 gpm (3.8 L/min) flow restrictor</i> <input type="checkbox"/> G <i>Grid Drain</i>	<ul style="list-style-type: none"> - ASME A112.18.1/CSA B125.1 - NSF/ANSI 372 - UL# E311169 (USA & Canada) - Buy American Act Compliant - ADA Compliant
<p>Note: Append appropriate suffix to model number.</p>	<h3>Warranty</h3>
<p>Options <i>(sold as separate line items)</i></p>	<p>Limited Lifetime - to the original end purchaser in consumer/residential installations. 10 Years - for commercial/industrial installations. Refer to www.symmons.com/warranty for complete warranty information.</p>
<input type="checkbox"/> RC6960 <i>Remote Control</i> <input type="checkbox"/> SD6960BL <i>Matching ORIGINS soap dispenser Battery</i> <input type="checkbox"/> SD6960BF <i>Matching ORIGINS soap dispenser</i> <input type="checkbox"/> USDP8 <i>8 Inch Deck Plate</i> <input type="checkbox"/> SF259 <i>Converts S6960B to AC powered (S6960E)</i> <input type="checkbox"/> SF278 <i>120V Cable 4.5 feet long Hard wired 15 Amp circuit. (QTY:10) 12 Volt Outputs, 4.2A Any combination of devices 10 devices maximum (SF277 not included)</i> <input type="checkbox"/> 8210CK <i>MaxLine® Tempering Valve</i>	

Architectural/Engineering Specification

Symmons Origins ActivSense Sensor Lavatory Faucet_____ Includes LEED rating, hygiene flush, solid brass body, adjustable settings, ADA compliant, single hole or 4" center (optional deck plate included), and power supply that is interchangeable with 6 AA batteries, 0.5 gpm (1.9 L/min) flow rate standard. 10 Year transferable Warranty. ASME A112.18.1/CSA B125.1, NSF/ANSI 372, UL# E311169 (USA & Canada), Buy American Act Compliant, ADA Compliant. Available options: "STS - Stainless Steel finish", "035 - 0.35 gpm (1.3 L/min) flow restrictor", "10 - 1.0 gpm (1.3 L/min) flow restrictor", and "G - Grid Drain".

Power Layout

1 Devices - 1 Power Supply

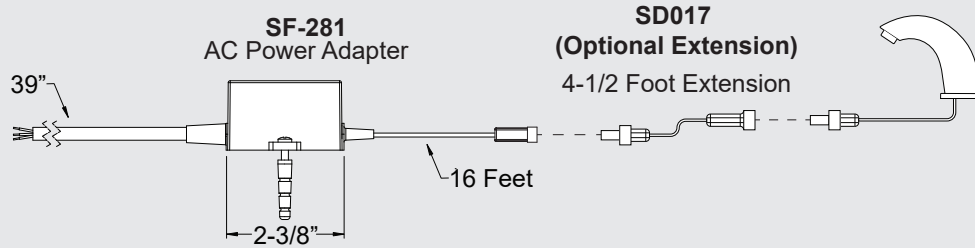

2 Devices - 1 Power Supply

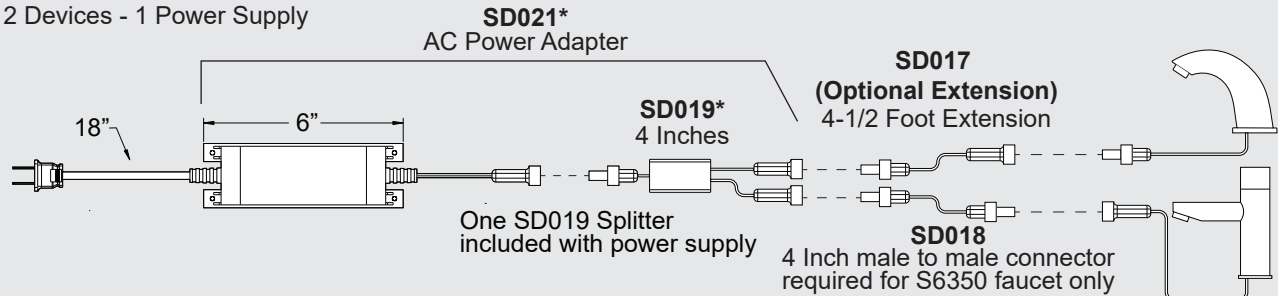

*SD019 is required when powering a faucet from the SD021 power supply.

6 Devices - 2 Power Supply

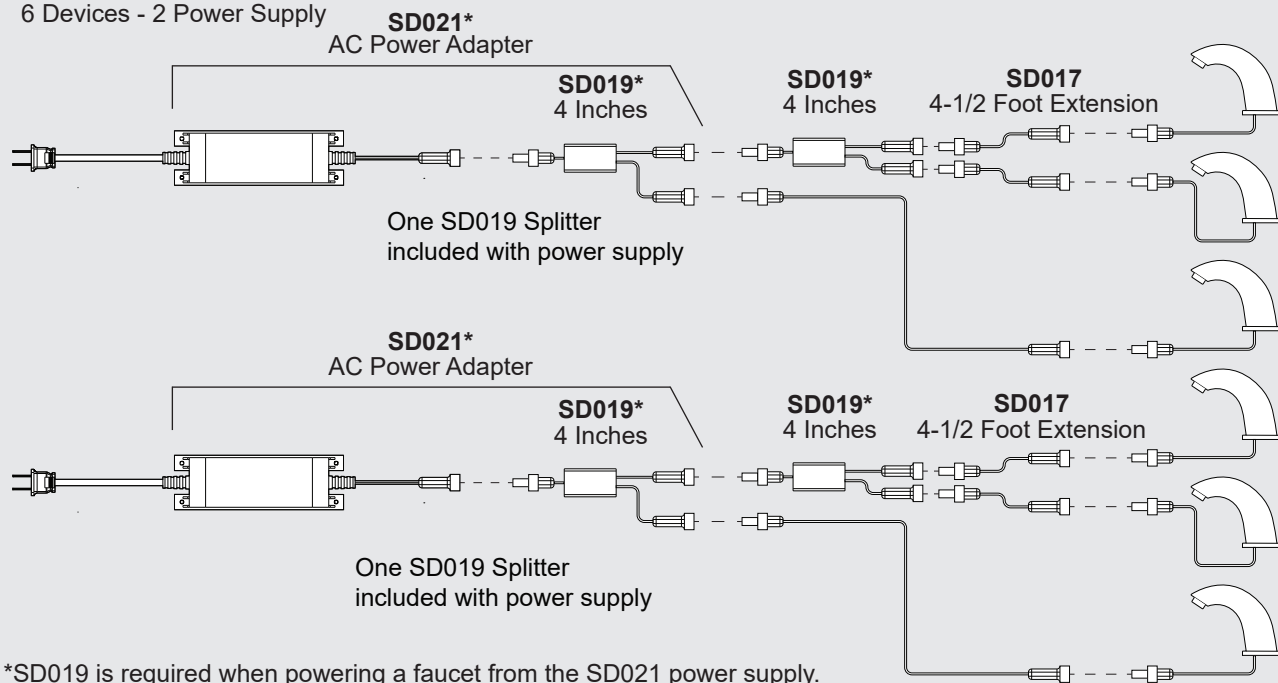

*SD019 is required when powering a faucet from the SD021 power supply.

10 Devices - 1 Power Supply

SF278
 120V Cable 4.5 feet long
 Hard wired 15 Amp circuit.
 (QTY:10) 12 Volt Outputs , 4.2A
 Any combination of devices
 10 devices maximum
 (SF277 not included)

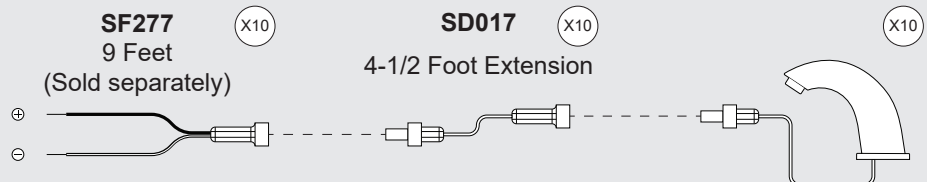
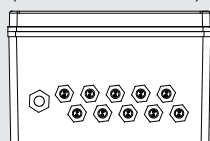

Dimensions

S6960B / S6960E

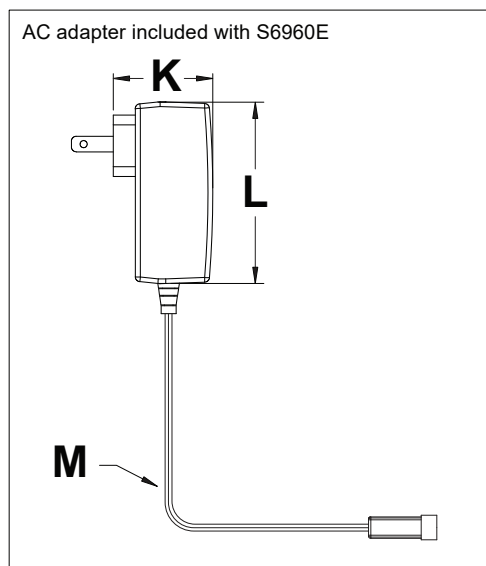
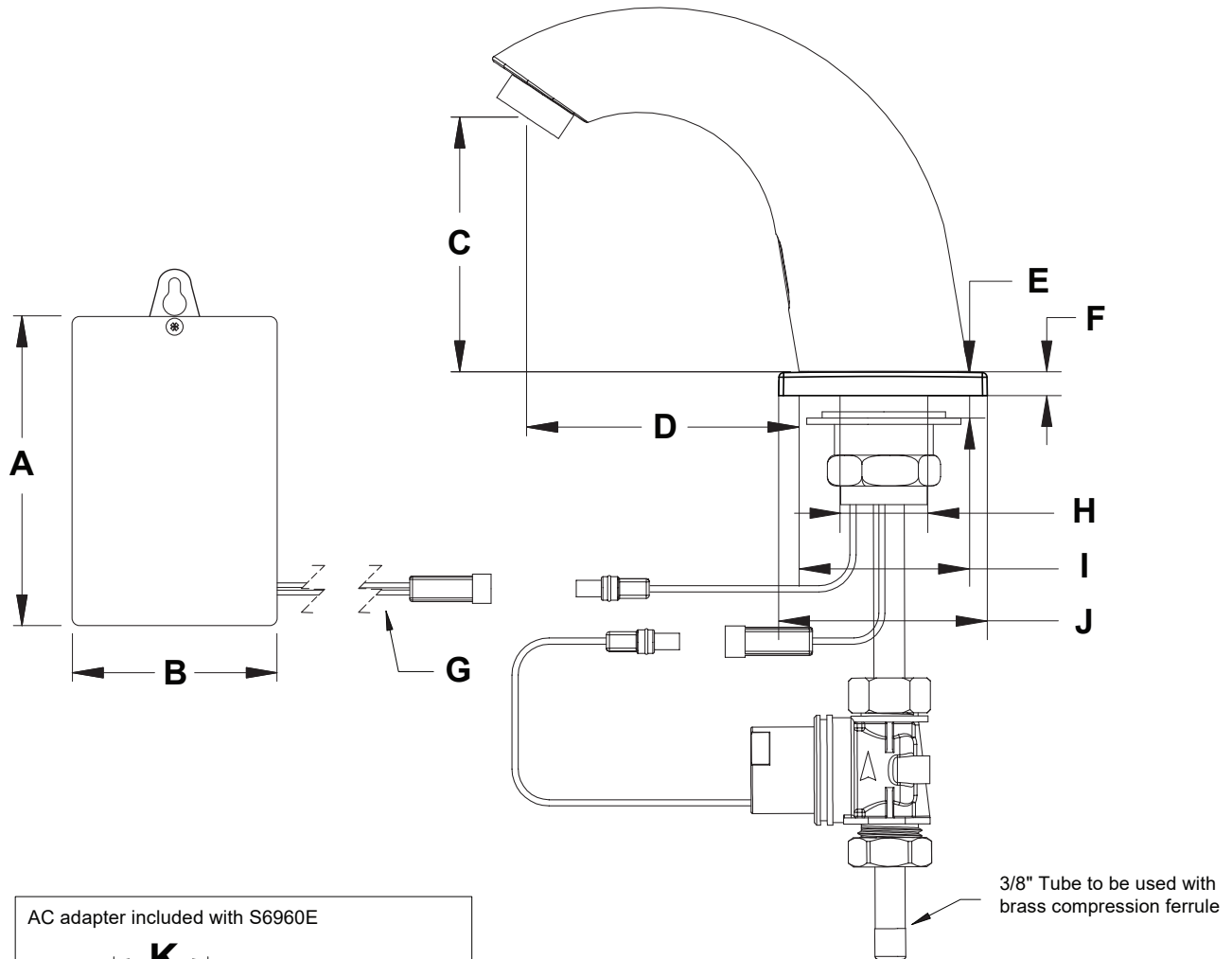

Measurements	
A	5" , 127 mm
B	3" , 76 mm
C	3-1/4" , 82 mm
D	3-1/2" , 88 mm
E	Deck Thickness Max: 1-3/8" With Deck Plate - Max: 1"
F	5/16" , 8 mm
G	18" , 457 mm
H	Ø Min:1-1/8" , 28 mm Ø Max:1-1/2" , 38 mm
I	Ø 2-1/8" , 55 mm
J	2-5/8" , 67 mm
K	1-5/8" , 41 mm
L	2-7/8" , 74 mm
M	15' , 4.5 m

Note: Dimensions subject to change without notice.

Emplacement:



SYMMONS® Origins ActivSense™



Comprend une plaque de pont de 4"

S6960B & S6960E

Robinet de lavabo à capteur

Soumission des spécifications

Numéros de modèle	Faits saillants des fonctionnalités
<input type="checkbox"/> S6960B <i>Robinet de lavabo à capteur d'alimentation unique. 6 piles de 1.5 V incluses</i> <input type="checkbox"/> S6960E <i>Robinet de lavabo à capteur d'alimentation unique. Transformateur 9V</i>	<ul style="list-style-type: none"> • Cote LEED • Rinçage hygiénique • Corps en laiton massif • Paramètres ajustables • Conforme à l'ADA • Trou unique ou centre de 4", plaque de pont en option incluse • La source d'alimentation est interchangeable avec 6 piles AA • 0,5 gpm (1,9 l / min) Standard de débit
Options de finition/Modifications	Conformité
<input type="checkbox"/> STS <i>Finition en acier inoxydable</i> <input type="checkbox"/> 035 <i>Limiteur de débit de 0,35 gpm (1,3 L/min)</i> <input type="checkbox"/> 10 <i>Limiteur de débit de 1,0 gpm (3,8 L/min)</i> <input type="checkbox"/> G <i>Grille Vidange</i>	<ul style="list-style-type: none"> - ASME A112.18.1/CSA B125.1 - NSF/ANSI 372 - UL# E311169 (USA & Canada) - Buy American Act Conforme - ADA Conforme
Remarque: ajoutez le suffixe approprié au numéro de modèle.	
Choix (vendus en tant qu'éléments de ligne distincts)	Garantie
<input type="checkbox"/> RC6960 <i>Télécommande</i> <input type="checkbox"/> SD6960BL <i>Distributeur de savon ORIGINS assorti</i> <input type="checkbox"/> SD6960BF <i>Distributeur de savon ORIGINS assorti</i> <input type="checkbox"/> USDP8 <i>Plaque de pont de 8 pouces</i> <input type="checkbox"/> SD010 <i>Convertit le S6960B en alimentation CA (S6960E)</i> <input type="checkbox"/> SF278 <i>Câble 120V 1.3716 m de long Circuit câblé de 15 ampères. (QTÉ : 10) Sorties 12 volts, 4,2 A Toute combinaison d'appareils 10 appareils maximum (SF277 non inclus)</i> <input type="checkbox"/> 8210CK <i>Vanne de trempage Maxline®</i>	<p>Durée de vie limitée - jusqu'à la fin d'origine consommateur/acheteur résidentiel installations.</p> <p>10 ans - pour commercial/industriel installations. Faire référence à www.symmons.com/garantie pour informations complètes sur la garantie.</p>

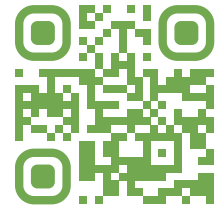

Spécification architecturale/d'ingénierie

Robinet de lavabo à capteur Symmons Origins ActivSense _____ Comprend une cote LEED, une chasse d'eau hygiénique, un corps en laiton massif, des réglages réglables, un trou unique ou un centre de 4 po (plaque de pont en option incluse) et une alimentation interchangeable avec 6 piles AA, 0,5 gpm (1,9 l / min) Standard de débit. Garantie transférable de 10 ans. ASME A112.18.1 /CSA B125.1, NSF/ANSI 372, UL# E311169 (États-Unis et Canada) et Buy American Act Conforme, ADA Conforme. Options disponibles : "STS - Finition acier inoxydable", "035 - Limiteur de débit 0,35 gpm (1,3 L/min) ", " Limiteur de débit 10 - 1,0 gpm (1,3 L/min)" et "G - Grid Drain".

Disposition de puissance

1 Appareils - 1 Alimentation

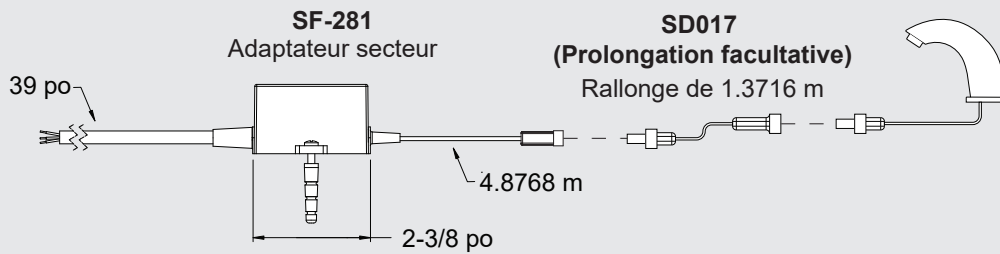

2 appareils - 1 alimentation

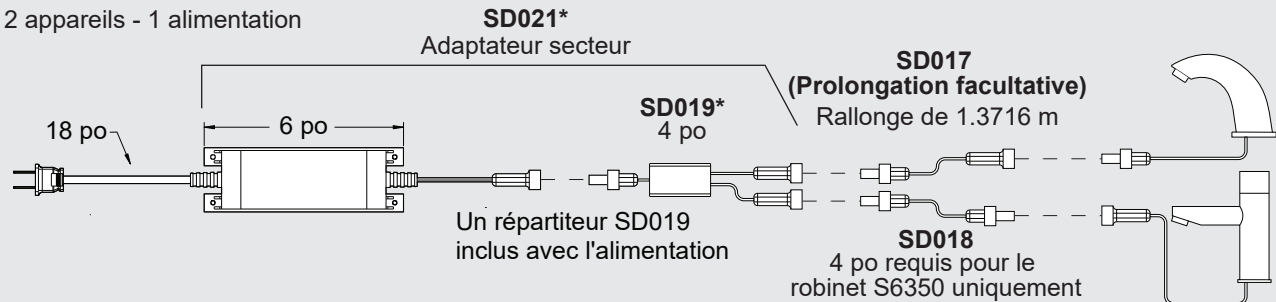

*SD019 est requis lors de l'alimentation d'un robinet à partir de l'alimentation SD021.

6 appareils - 2 alimentations

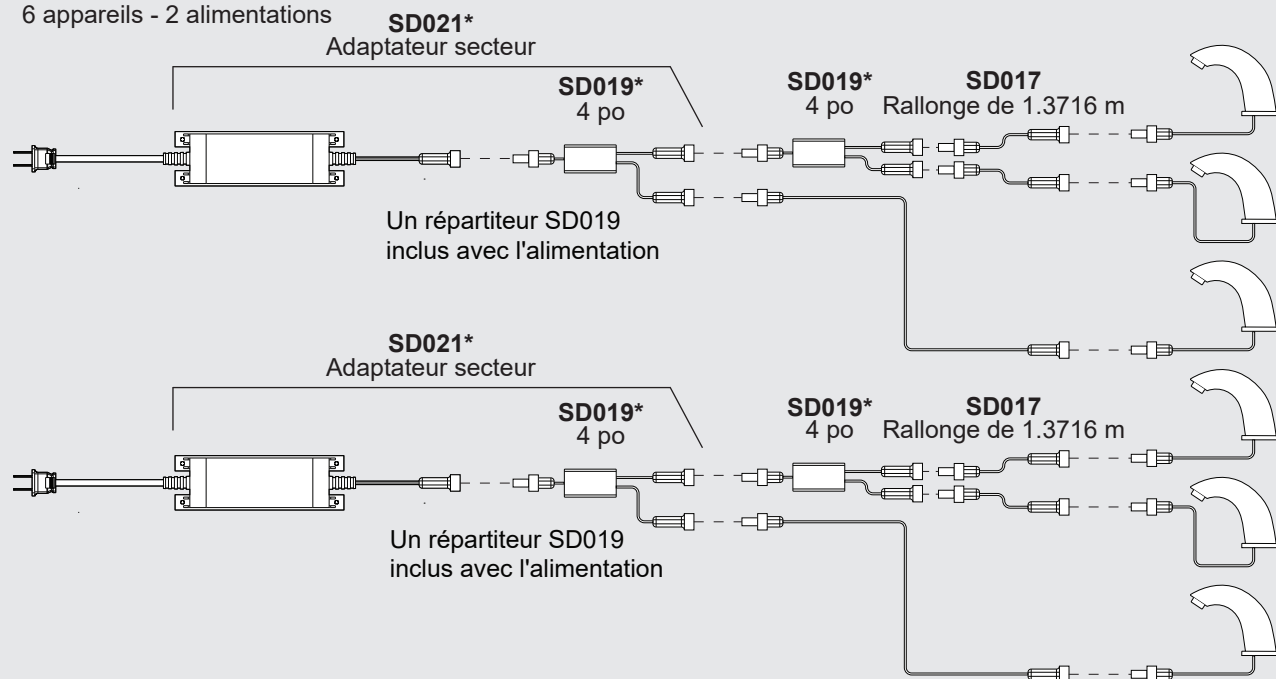

*SD019 est requis lors de l'alimentation d'un robinet à partir de l'alimentation SD021.

10 appareils - 1 alimentation

SF278
Câble 120V 1.3716 m de long
Circuit câblé de 15 ampères.
(QTE : 10) Sorties 12 volts, 4,2 A
Toute combinaison d'appareils
10 appareils maximum
(SF277 non inclus)

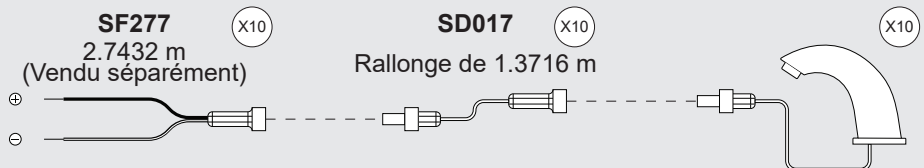
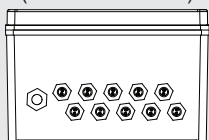

Dimensions

S6960B / S6960E

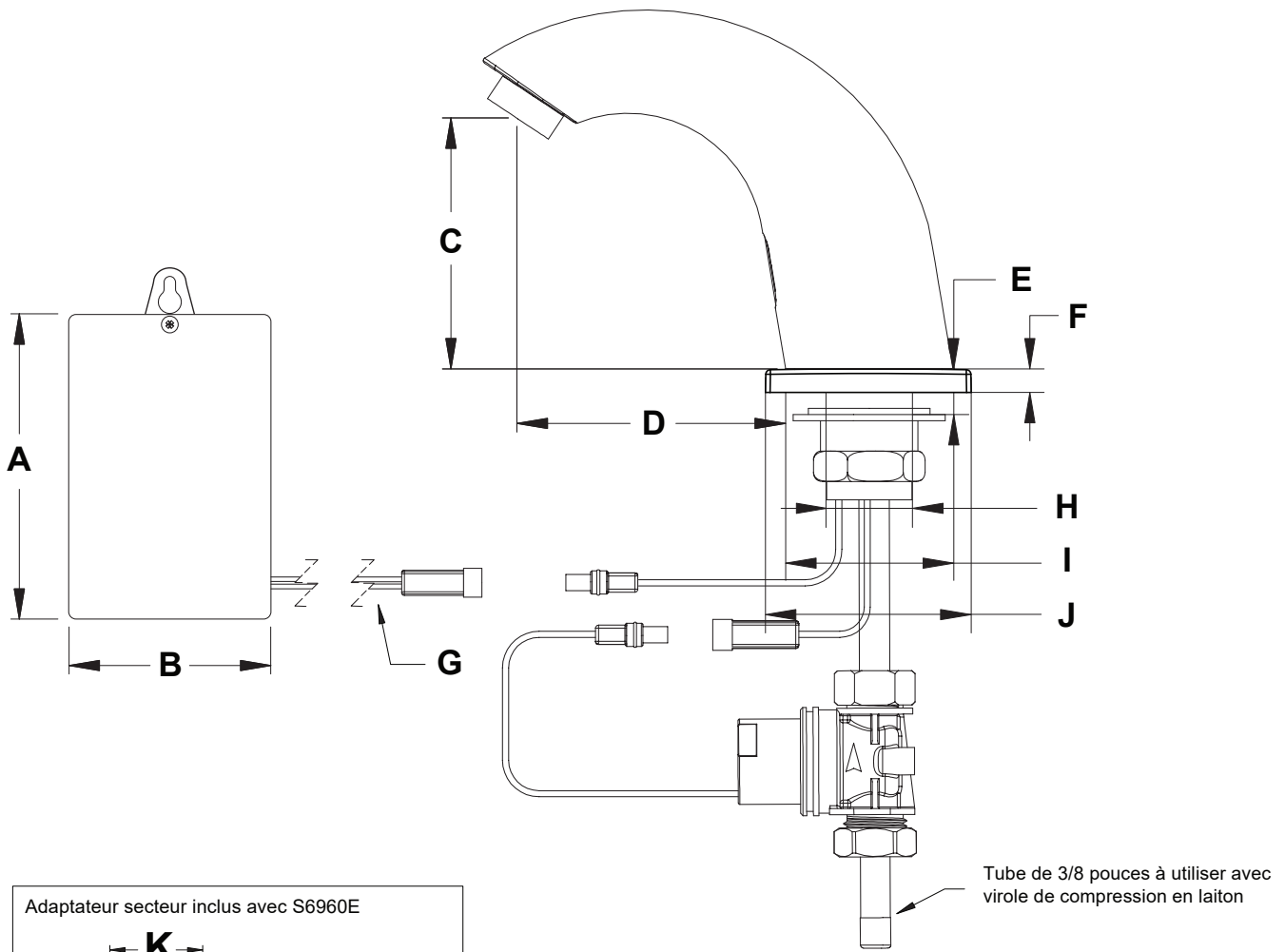

Adaptateur secteur inclus avec S6960E

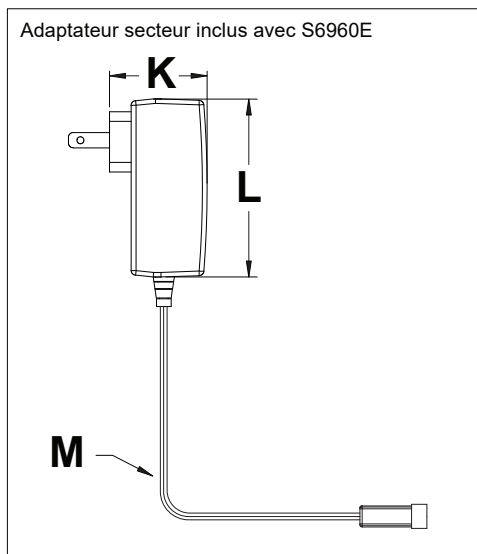

Des mesures	
A	127 mm, 5 po
B	76 mm, 3 po
C	82 mm, 3-1/4 po
D	88 mm, 3-1/2 po
E	Épaisseur du pont Max: 1-3/8 po Avec plaque de pont - Max: 1 po
F	8 mm, 5/16 po
G	457 mm, 18 po
H	Ø Min: 28 mm, 1-1/8 po Ø Max: 38 mm, 1-1/2 po
I	Ø 55 mm, 2-1/8 po
J	67 mm, 2-5/8 po
K	41 mm, 1-5/8 po
L	74 mm, 2-7/8 po
M	4.5 m

Remarque: Dimensions sujettes à changement sans préavis.