

Features

- Solid brass construction
- Aerated and hidden
- Single hole installation
- Ceramic disc valve cartridge
- Lead Free: Low lead product (less than 0.25%)

Colors (Finishes)

- Chrome: BF1778-110
- Matte black: BF1778-160

Maximum flow rate

- 5.7 L/min (1.5 gpm)

Certifications

The specified model meets or exceeds the following standards:



Installation Notes

This product must be installed following the installation instructions provided.

WARRANTY

Kalia Inc. guarantees all aspects of its products to be free of defects in material and workmanship for normal residential use. **Refer to the warranty included with the Kalia products for details.**

Product dimensions:

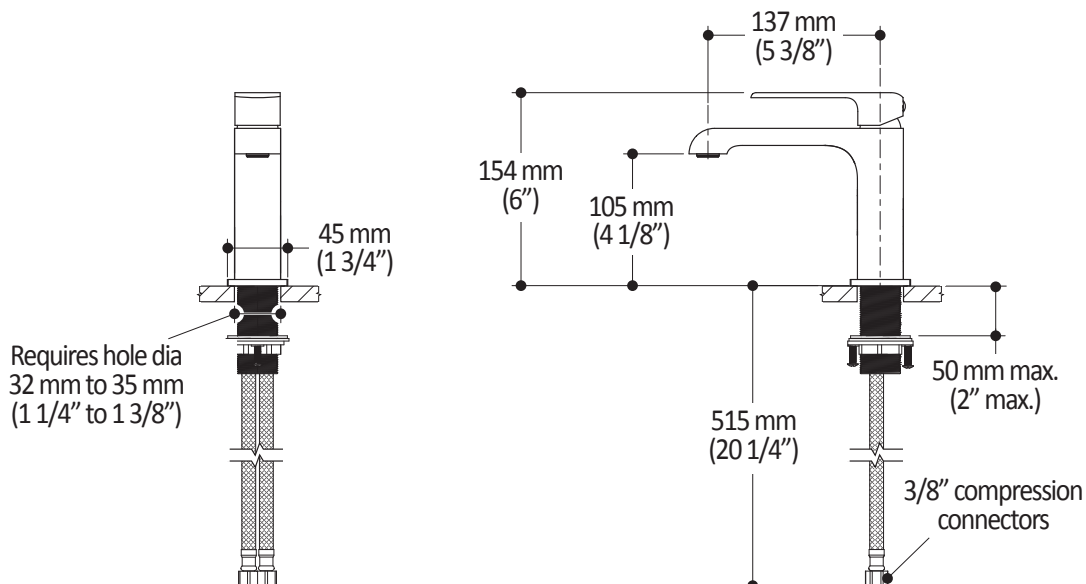

Important: Dimensions are approximated and are subject to changes. Please refer to the installation instructions.