

## Features

- Three-function pull-down sprayhead with touch control allows you to switch between aerated stream, Sweep® spray, and Boost technology
- Sweep® spray provides a wide, powerful blade of water that sweeps your dishes and sink clean
- Boost technology increases the flow rate by 30% with the press of a button. Use Boost with stream for faster filling or with Sweep® spray for more powerful cleaning
- ProMotion® technology allows the pull-down sprayhead to swivel for more comfortable use
- MasterClean™ sprayface features an easy-to-clean surface that withstands mineral buildup and maximizes spray performance
- High-arch spout offers vertical clearance for tall cookware and pitchers
- Single lever handle makes adjusting water temperature easy with one hand
- 1.5 gpm (5.7 lpm) maximum flow rate at 60 psi (4.14 bar)
- Temperature memory allows faucet to be turned on and off at the temperature set during prior usage
- KOHLER® ceramic disc valves exceed industry longevity standards for a lifetime of durable performance
- DockNetik® secure docking system locks sprayhead into place when not in use

## Material

- Premium metal construction for durability and reliability
- KOHLER® finishes resist corrosion and tarnishing

## Installation

- Single-hole installation (three-hole escutcheon sold separately)
- Flexible supply lines simplify installation

## Adapters, Rough-in and Extension Kits

1327990 Range: 2-1/2" (64 mm) - 4-5/8" (117 mm)

## Recommended Products/Accessories

K-77685 Single-Cartridge Water Filtration System  
K-77686 Double-Cartridge Water Filtration System  
K-77687 single replacement filter cartridge  
K-77688 Replacement Filter Cartridges, Two-Pack

## Optional Products/Accessories

K-24461 Three-hole kitchen faucet escutcheon



**ADA** **CSA B651**

## Codes/Standards







ASME A112.18.1/CSA B125.1  
NSF/ANSI/CAN 61  
NSF/ANSI/CAN 372  
All applicable US Federal and State material regulations  
DOE - Energy Policy Act 1992  
California Energy Commission (CEC)  
ADA  
ICC/ANSI A117.1  
CSA B651  
IAPMO Certification

## KOHLER® Faucet Lifetime Limited Warranty

See website for detailed warranty information.

## Available Colors/Finishes

*Color tiles intended for reference only.*

Color	Code	Description
	CP	Polished Chrome
	VS	Vibrant® Stainless
	BL	Matte Black
	2MB	Vibrant® Brushed Moderne Brass
	BMB	Matte Black with Moderne Brass
	CBL	Matte Black with Polished Chrome

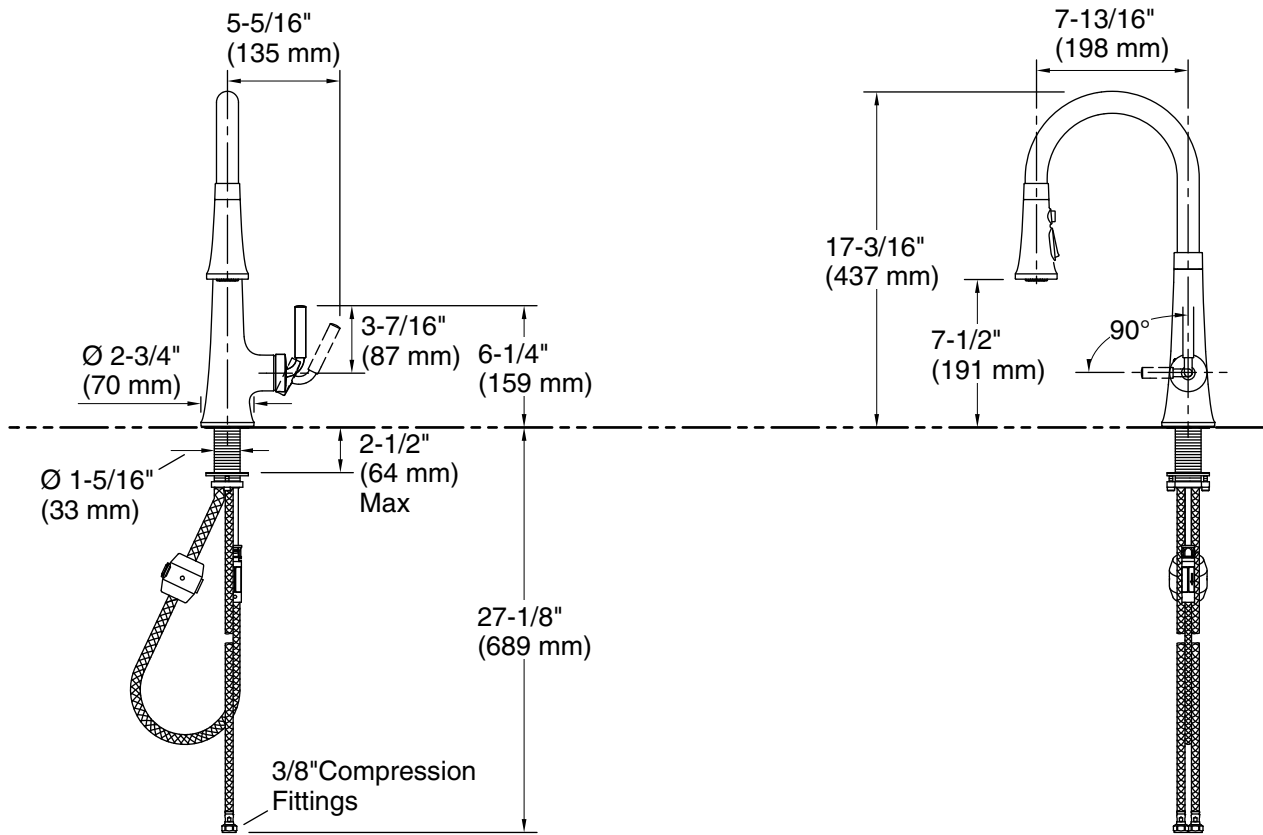

## Technical Information

All product dimensions are nominal.

### Faucet:

Flow rate: 1.5 gal/min (5.7 l/min)

### Spout:

Spout reach: 7-3/4" (198 mm)

## Notes

Install this product according to the installation instructions.

ADA complaint for faucet handles only.

ADA, CSA B651 compliant when installed to the specific requirements of these regulations.