

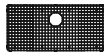

Included Accessories

cUPC®



BGDS33S

Optional Accessories



C09S



MB100



DBR10S



CM100

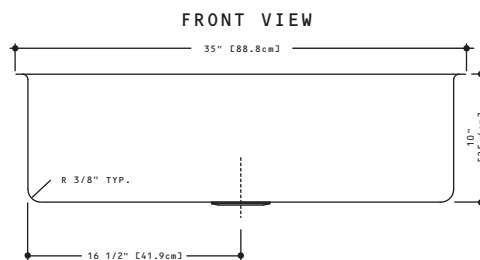
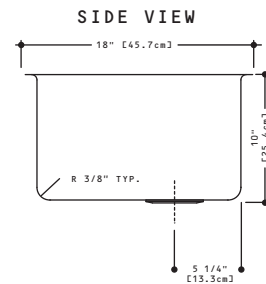
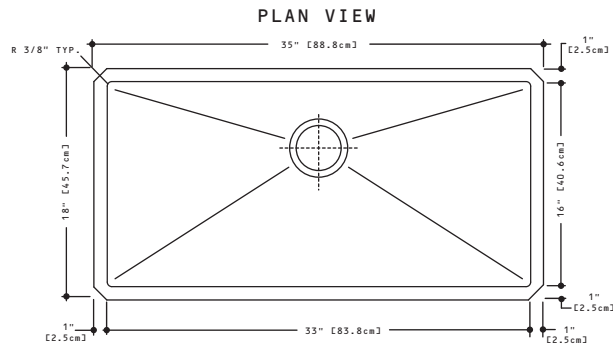

KCUS36A/10-10BG SPECIFICATION

Model KCUS36A/10-10BG is a single bowl undermount sink, with 10 mm radius coved corners, manufactured for Franke Kindred Canada Limited from 18 gauge, 18-10 stainless steel. All exposed surfaces have a #4 commercial satin finish. Sink has sound deadening pads and is fully undercoated. Basket strainer waste fitting (3 1/2", 89 mm) and template are included. Sink is backed with a limited buyer lifetime warranty.

- O.D. 18" x 35" x 10" (45.7 x 88.8 x 25.4 cm)
- **36" base cabinet is recommended**
- **36" cabinet - minimum to accept sink bowls**

FUN# 123.0178.911



Accessoires inclus

cUPC®

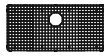

BGDS33S

Accessoires optionnels



C09S



MB100



DBR10S



CM100

VUE EN PLAN

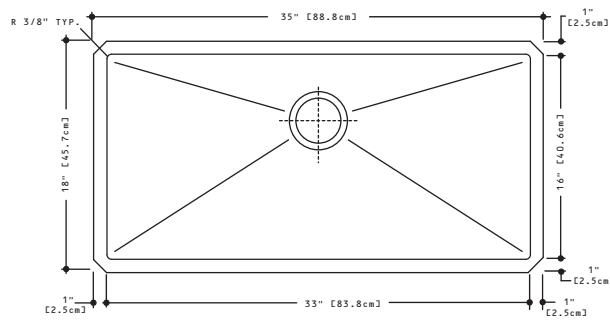

VUE DE CÔTÉ

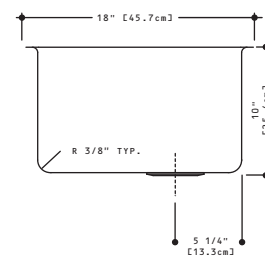

VUE DE FACE

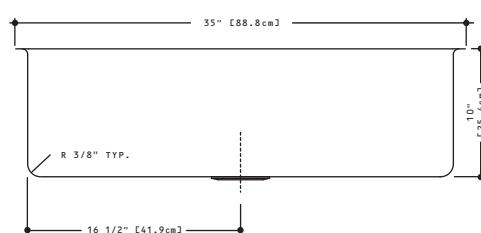

KCUS36A/10-10BG DONNÉES TECHNIQUES

Le modèle KCUS36A/10-10BG est un évier pour installation sous le comptoir à une cuvette, coins arrondis à gorge de 10 mm, fabriqué d'acier inoxydable 18-10, calibre 18 pour Franke Kindred Canada Limitée. Toutes les surfaces apparentes ont un fini satiné commercial # 4. L'évier est muni de tampons amortisseurs de son et est revêtu d'un enduit sur toute la surface inférieure. Une bonde de vidage à crépine-panier de 89 mm (3 1/2 po) et un gabarit sont compris. Une garantie à vie limitée est offerte à l'acheteur.

- Dimensions hors-tout: 45.7 x 88.8 x 25.4 cm (18 x 35 x 10 po)
- **Une armoire de 91.4 cm (36 po) est recommandée**
- **Armoire de 36 po - minimum recevant les cuvettes d'évier**

FUN# 123.0178.911