



BF1373

STANDARD: Showerhead and 45° Wallarm

SPECIFICATIONS

Features

- Water 1/2" male inlet NPT
- Diameter of 117mm (4 5/8")
- Anti-scale system with soft sprays
- Adjustable orientation swivel
- PVD finish (Physical Vapour Deposit): A high technology process that protects the surface finish for increased durability

Colors (Finishes)

- Chrome : BF1373-110
- Brushed Nickel PVD : BF1373-120

Certifications

The specified model meets or exceeds the following standards;

- ASME A112.18.1 / CSA B125.1



Packaging

- **Dimensions:** 362mm x 184mm x 191mm (14 1/4" x 7 1/4" x 7 1/2")
- **Volume:** 0.45 cu ft (0.013 cu m)
- **Total weight:** 3.62 lb (1.64 kg)

Maximum flow rate

- 9.5 liters/min. (2.5 gallons/min.) at 80 psi



Installation Notes

This product must be installed following the installation instructions provided.

WARRANTY

Kalia Inc. guarantees all aspects of its products to be free of defects in material and workmanship for normal residential use. **Refer to the warranty included with the Kalia products for details.**

Product dimensions:

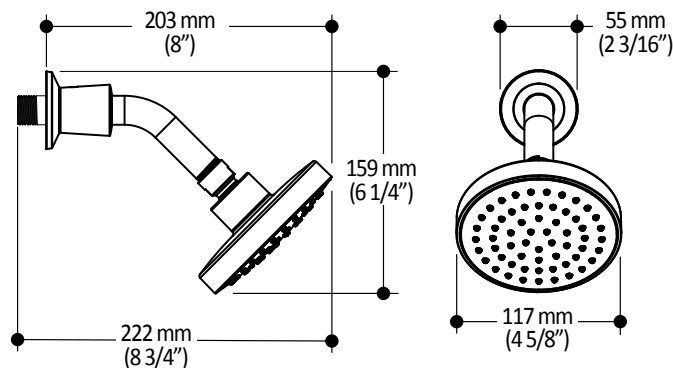

Important: Dimensions are approximated and are subject to changes. Please refer to the installation instructions.

Kalia inc.
1355, 2nd Street
Sainte-Marie (Quebec)
Canada G6E 1G9

t. 1-418-387-9090
1 877 GO KALIA (1-877-465-2542)
f. 1-418-387-9089
www.KaliaStyle.com