

STONEWOOD

BATH CABINETRY





STONEWOOD
**FUTURE
FORESTS**

ONE TREE PLANTED FOR EVERY VANITY SOLD

We have partnered with WEARTH, a family of farmers, as a Forest Farmer Partner. Brad and Rebecca Rabiey, third generation farmers and founders of WEARTH, were featured on and backed by Dragons' Den in 2012.

Each tree will be planted in Canadian soil, across the country.

In addition to your physical tree being planted, you will have the opportunity to plant a tree in our virtual forest!

More details at:

www.futureforests.stonewoodbath.com

www.createyourforest.ca/visit/stonewoodbath



Scan me

OUR GOAL

Stonewood is the superior choice vanity with the proven quality you expect, the timeless style you love, and the finishing options that fulfill your vision. We continue to be an industry leader, always learning and improving to serve you better. Delivering exceptional service and happiness to our customers is our top priority.

Our program allows you to mix and match products, styles, and colours to give you the bathroom vanity of your dreams.

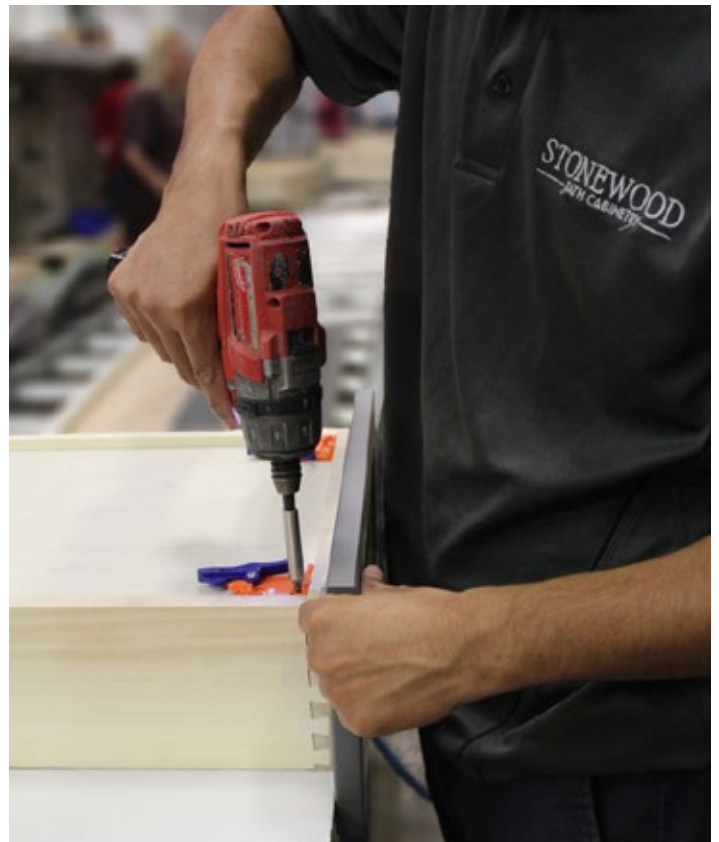

QUICK TURNAROUND

Once your order has been placed, expect to receive your unique vanity in 2 - 3 weeks.

HUNDREDS OF COLOUR COMBINATIONS

Find the perfect match to suit your style!

CANADIAN OWNED & OPERATED

Our product is assembled and inspected in Barrie, Ontario.

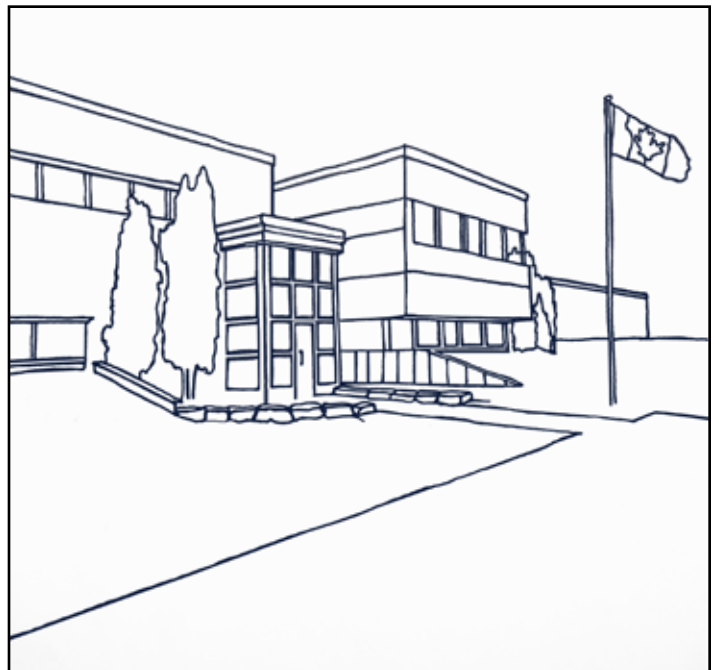

ON THE COVER:

Vanity: 54" Dawn (Bellrose)

Vanity top: Glacier quartz

Hardware: Brushed Nickel Bevelled handles

Mirrors: 36" Brushed Nickel Round metal mirror



36" White (V-Groove Shaker) vanity with Fuzion quartz top and Brushed Nickel Long Curved handles

SUPERIOR QUALITY

Stonewood Bath Cabinetry prides itself in providing superior construction integrity. The following features come standard with our vanities:

- Solid hardwood face-frame, back-frame, and furniture kick
- Hardwood dovetail drawer boxes
- 5/8" plywood interior/end gables, dust kick, and floor
- Full-extension, adjustable soft-closing hardware
- Inserted door and drawer bumpers

We stand behind the quality of our products and offer warranties on all our vanities, quartz tops, accessories, and cabinet hardware.



Further details can be found at:
www.stonewoodbath.com/warranty

Navy Grey (Bellrose) vanity with Fantasy quartz top and Brushed Nickel Modern knobs



CABINETY OPTIONS

WIRE-BRUSHED OAK PREMIUM COLLECTION



BROWN OAK (Bellrose)



DESERT OAK (Bellrose)



URBAN OAK (Bellrose)



WEATHERED OAK (Bellrose)

FIVE SHADES OF GREY PREMIUM PAINTED COLLECTION



DAWN (Bellrose)



GRAPHITE (Bellrose)



MOSS GREY (Bellrose)



NAVY GREY (Bellrose)



SMOKE (Bellrose)

PAINTED CLASSIC COLLECTION

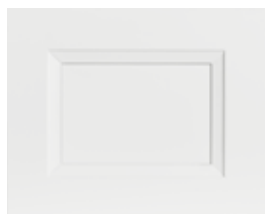

WHITE (Bellrose)

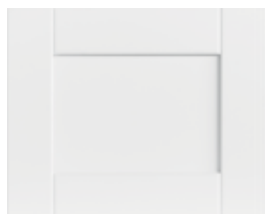

WHITE (V-Groove Shaker)

Five-piece door styles explained:

BELLROSE

Recessed centre panel with a soft, linear profile.

SHAKER

A flat centre panel and square edges. Minimal detailing and profile.

V-GROOVE SHAKER

Shaker-style with an added groove at the joints.

STAINED CLASSIC COLLECTION



CHESTNUT (Shaker)



DRIFTWOOD (Bellrose)



ESPRESSO (Shaker)



LAKWOOD (Bellrose)

VANITY STYLES



72" Lakewood (Bellrose) vanity with Fantasy quartz top, Brushed Nickel Bevelled handles, and two 26" Lakewood mirrors

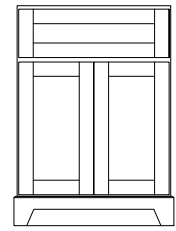

24" VANITY

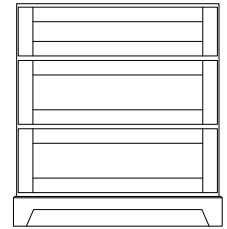

30"/36" VANITY†
(DRESSER STYLE)

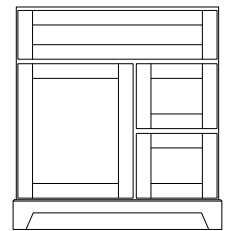

30"/36" VANITY
(LEFT OR RIGHT DRAWER)

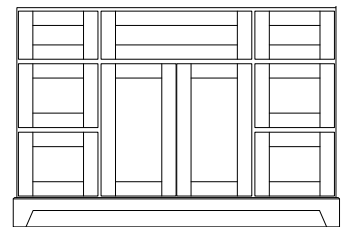

42"/48"/54"/60" VANITY
(SINGLE BOWL)

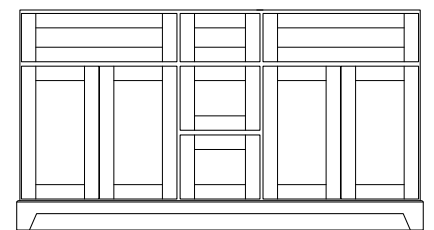

60"/72" VANITY
(DOUBLE BOWL)

Urban Oak (Bellrose) vanity with Chrome Slim handles



†30"/36" Dresser Style vanities are available in all finishes except Chestnut (Shaker) and Espresso (Shaker).

WIRE-BRUSHED OAK

PREMIUM COLLECTION

Our Wire-Brushed Oak Premium Collection is stunning! We enhance the original wood grain of oak by wire-brushing the surface to expose its natural characteristics and beauty. Multiple coats of stain and glaze further enhance the natural deep oak grain. The final product is a premium wood finish that will complement any décor.

Collection Options:



BROWN OAK (*Bellrose*)
Rich and refined. Brown Oak's caramel undertones bring warmth and character into any bathroom.



DESERT OAK (*Bellrose*)
Light, rustic, and earthy. Desert Oak has compelling wood grains which offer a natural, organic aesthetic.



URBAN OAK (*Bellrose*)
Dark and rich. Urban Oak provides dark wood grains with an elegant finish.



WEATHERED OAK (*Bellrose*)
Rustic and warm. Weathered Oak offers a similar feel to raw wood and complements traditional décor.





Brown Oak (Bellrose) vanity with Suede quartz top

1. **24" VANITY** Shown in Weathered Oak (Bellrose) with One-Piece Porcelain top with integrated sink and Brushed Nickel Modern knobs.
2. **30"/36" RIGHT OR LEFT DRAWER VANITY** Shown in 36" Urban Oak (Bellrose) right drawer with Carrera quartz top and Chrome Slim handles.
3. **30"/36" DRESSER STYLE VANITY** Shown in 36" Desert Oak (Bellrose) with Pewter quartz top and Black Long Curved handles.
4. **42"/48"/60" SINGLE BOWL VANITY** Shown in 48" Brown Oak (Bellrose) with Suede quartz top and Brushed Nickel Modern knobs.
5. **60"/72" DOUBLE BOWL VANITY** Shown in 72" Urban Oak (Bellrose) with Dover White quartz top, Brushed Nickel Bevelled handles, and two 26" Urban Oak mirrors.

NOTE: We do our best to accurately represent the true colour, tone, and grain pattern of our products in print form. There may be slight colour differences between these printed images, samples in store, and from product to product.

FIVE SHADES OF GREY

PREMIUM PAINTED COLLECTION

Set your bathroom apart with one of our premium painted grey finishes! These 5 trendsetting colours are sure to add the WOW factor to any sized bathroom.

Collection Options:



NEW!

DAWN
Similar to Beauti-Tone Metropolis Mood D35-4-0526-0 and Benjamin Moore Pilgrim Haze 2132-50.



GRAPHITE
Similar to Beauti-Tone Warehouse District F045-4 and Benjamin Moore Overcoat CC-544.



NEW!

MOSS GREY
Similar to Beauti-Tone Stairway to Heaven C4-2-0479-4 and Benjamin Moore Kitty Gray 1589.



NAVY GREY
Similar to Beauti-Tone Rooftop at Midnight F034-3 and Benjamin Moore Hale Navy HC-154.



SMOKE
Similar to Beauti-Tone Roller Skates ST016 and Benjamin Moore Metropolitan AF-690.





Moss Grey (Bellrose) vanity with Carrera quartz top



1. **24" VANITY** Shown in Smoke (Bellrose) with One-Piece Porcelain top with integrated sink and Brushed Nickel Bevelled handles.
2. **30"/36" RIGHT OR LEFT DRAWER VANITY** Shown in 36" Graphite (Bellrose) left drawer with Pewter quartz top and Black Curved handles.
3. **30"/36" DRESSER STYLE VANITY** Shown in 30" Dawn (Bellrose) with Dover White quartz top and Brushed Nickel Long Curved handles.
4. **42"/48"/54"/60" SINGLE BOWL VANITY** Shown in 48" Navy Grey (Bellrose) with Fantasy quartz top and Brushed Nickel Modern knobs.
5. **60"/72" DOUBLE BOWL VANITY** Shown in 72" Moss Grey (Bellrose) with Carrera quartz top, Oil Rubbed Bronze Modern knobs, and two 24" Brushed Nickel metal mirrors.

NOTE: We do our best to accurately represent the true colour, tone, and grain pattern of our products in print form. There may be slight colour differences between these printed images, samples in store, and from product to product.

PAINTED CLASSIC COLLECTION

For a clean look, our Painted Classic Collection offers two door styles. Our vanities have a smooth uniform finish; the result of applying multiple coats of paint and sanding in between each coat. This technique results in a beautiful, satin-like appearance; a standout piece in any bathroom.

Collection Options:



WHITE (Bellrose)
Our five-piece Bellrose style door painted in a clean, crisp white. Similar to Beauti-Tone *Here Comes The Bride* WB001-0 and Benjamin Moore *Chantilly Lace* OC-65.

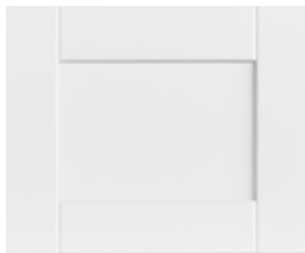

WHITE (V-Groove Shaker)
Our five-piece shaker-style door with an added groove at the joints. Painted in a clean, crisp white. Similar to Beauti-Tone *Here Comes The Bride* WB001-0 and Benjamin Moore *Chantilly Lace* OC-65.



White (Bellrose) vanity with Seaside quartz top



White (Bellrose) vanity with Moonscape quartz top

1. **24" VANITY** Shown in White (V-Groove Shaker) with One-Piece Porcelain top with integrated sink and Brushed Nickel Modern knobs.
2. **30"/36" RIGHT OR LEFT DRAWER VANITY** Shown in 36" White (Bellrose) right drawer with Pewter quartz top and Chrome Curved handles.
3. **30"/36" DRESSER STYLE VANITY** Shown in 30" White (V-Groove Shaker) with Fuzion quartz top and Chrome Long Curved handles.
4. **42"/48"/54"/60" SINGLE BOWL VANITY** Shown in 48" White (Bellrose) with Seaside quartz top and Black Modern knobs.
5. **60"/72" DOUBLE BOWL VANITY** Shown in 72" White (V-Groove Shaker) with Carrera quartz top, Chrome Bar handles, and two 26" White mirrors.

NOTE: We do our best to accurately represent the true colour, tone, and grain pattern of our products in print form. There may be slight colour differences between these printed images, samples in store, and from product to product.

STAINED

CLASSIC COLLECTION

Our Stained Classic Collection features an assortment of popular wood stains and glazes, offered in a variety of door styles. Multiple coats of stain and glaze are applied by hand to achieve a deep, rich finish.

NOTE: 30"/36" Dresser Style vanities are available in all finishes except Chestnut (Shaker) and Espresso (Shaker).

Collection Options:



CHESTNUT (Shaker)
Chestnut brings an elegant, traditional look to your bathroom space. Seen here in Shaker door style, it has a slightly modern feel.



DRIFTWOOD (Bellrose)
Light and neutral. Driftwood is the perfect canvas to build upon, allowing you to pair it with almost any colour.



ESPRESSO (Shaker)
Deep, rich, dark brown. Espresso lends itself to warm, cozy, and slightly modern designs. A tasteful, smart look to any bathroom.



LAKEWOOD (Bellrose)
Modern, charming, and satiny. Lakewood offers hints of black, green, and dark grey. A chic and sophisticated centrepiece to your bathroom.

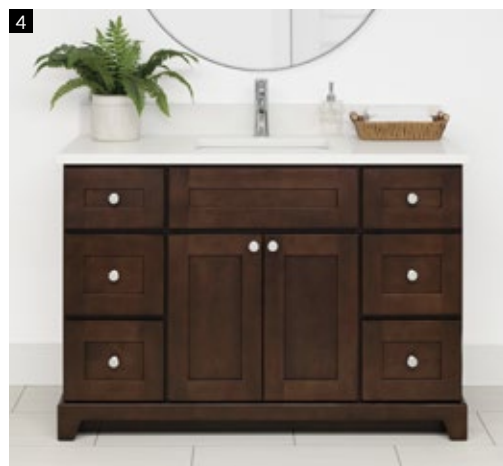
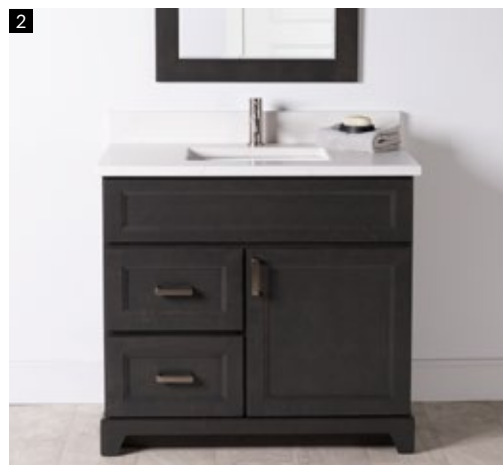
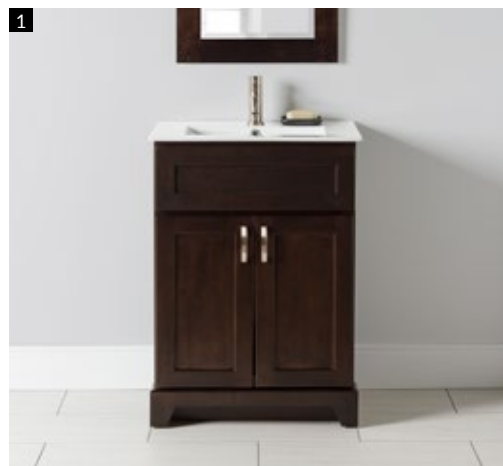



Lakewood (Bellrose) vanity with Monaco quartz top

1. **24" VANITY** Shown in Espresso (Shaker) with One-Piece Porcelain top with integrated sink and Brushed Nickel Curved handles.
2. **30"/36" RIGHT OR LEFT DRAWER VANITY** Shown in 36" Lakewood (Bellrose) left drawer with Carrera quartz top and Brushed Nickel Wide handles.
3. **30"/36" DRESSER STYLE VANITY** Shown in 36" Driftwood (Bellrose) with Pewter quartz top and Black Long Curved handles.
4. **42"/48"/54"/60" SINGLE BOWL VANITY** Shown in 48" Chestnut (Shaker) with Dover White quartz top and Chrome Modern knobs.
5. **60"/72" DOUBLE BOWL VANITY** Shown in 60" Driftwood (Bellrose) with Luna quartz top, Black Bar handles, and two 19 1/2" Driftwood mirrors.

NOTE: We do our best to accurately represent the true colour, tone, and grain pattern of our products in print form. There may be slight colour differences between these printed images, samples in store, and from product to product.

LINEN TOWER

INTEGRATION

Linen towers have a matching, finished interior. The standard option comes with open upper shelves or a door with left or right hinges that can be added at no additional charge.

Custom Integration:

No matter what your preference, our linen tower will complete the look of your bathroom. A linen tower can be installed in three different ways:

(1) Free standing – Linen towers are finished on all three sides making it a beautiful, stand-alone piece.

(2) Tight against a wall – The crown molding should be cut to have the linen tower crown and kick sit flush against the wall. The supplied filler strips then bridge the gap between the cabinet and wall to complete the installation.

NOTE: This cut should be performed on-site by a skilled trades professional.

(3) Integrated with your vanity – We factory cut your vanity top and side splash to ensure a snug fit between the linen tower and vanity cabinet. The linen tower decorative kick is also designed to integrate seamlessly behind the vanity decorative kick. Finally, a 3/4" colour-matched filler strip closes the gap between the cabinets to complete the installation.

When purchasing a linen tower, please consult with a sales associate and choose from the linen tower layout options. We will prepare the linen tower(s) according to your layout, facilitating the installation.

NOTE: Linen towers cannot be integrated with 24" vanities. If integrating linen towers with a 72" vanity, we recommend using two 19 5/8" mirrors. The width of the crown molding on the linen towers will prevent 26" mirrors from being centred over the sinks.



▲ Decorative kick integration



▲ Side splash is precut for Linen Tower integration





48" White (Bellrose) vanity with Carrera quartz top, Brushed Nickel Bevelled handles, linen tower, 26" mirror, and bath storage cabinet

HARDWARE

Stonewood Bath Cabinetry offers a wide range of handles and knobs to accentuate your bathroom furniture. Choose “no hardware” on the order form to customize the look even further with your own hardware.

BAR (96 mm)



BLACK



BRUSHED NICKEL



CHROME



OIL RUBBED BRONZE

BEVELLED (96 mm)



BLACK



BRUSHED NICKEL



CHROME



OIL RUBBED BRONZE

CURVED (96 mm)



BLACK



BRUSHED NICKEL



CHROME



OIL RUBBED BRONZE

SLIM (96 mm)



BLACK



BRUSHED NICKEL



CHROME



OIL RUBBED BRONZE

WIDE (96 mm)



BLACK



BRUSHED NICKEL



CHROME



OIL RUBBED BRONZE

LONG CURVED HANDLES
FOR DRESSER STYLE
VANITIES (320 mm)

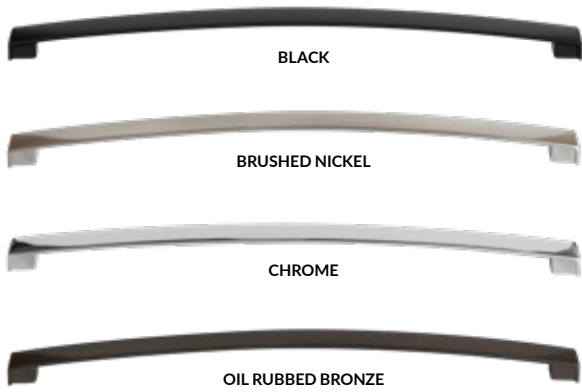

CLASSIC



BLACK



BRUSHED NICKEL



CHROME



OIL RUBBED BRONZE

MODERN



BLACK



BRUSHED NICKEL



CHROME



OIL RUBBED BRONZE



Hardware can transform your vanity!

Left:
36" Graphite (Bellrose) left drawer vanity with Carrera quartz top and Black Curved handles.

Right:
36" Graphite (Bellrose) left drawer vanity with Carrera quartz top and Brushed Nickel Bevelled handles.

QUARTZ TOPS

CREATE THE LOOK YOU LOVE!

Stonewood Bath Cabinetry strives to give our customers the luxury of choice. This continues with our 1¼" thick quartz vanity tops. We offer 16 colour options, two sink styles (available in white or linen), and choice of single, 4", or 8" on centre faucet hole drill patterns. All vanity tops include undermount sinks that are factory installed using industrial silicon. They also come standard with a matching 4" high backsplash and required side splashes based on the selected layout.



Glacier quartz top

TECHNICAL DETAILS

Our non-porous, 92% natural quartz stone is engineered for consistent colour. It is heat, scratch, and stain resistant. No sealing is required, making it maintenance free. Quartz vanity tops are available in standard widths to pair with our vanities. For an additional charge, custom cuts are available from the standard widths. Please consult with an in-store sales representative for assistance with the custom-cut top measurements.

FAUCET HOLE DRILL PATTERN OPTIONS

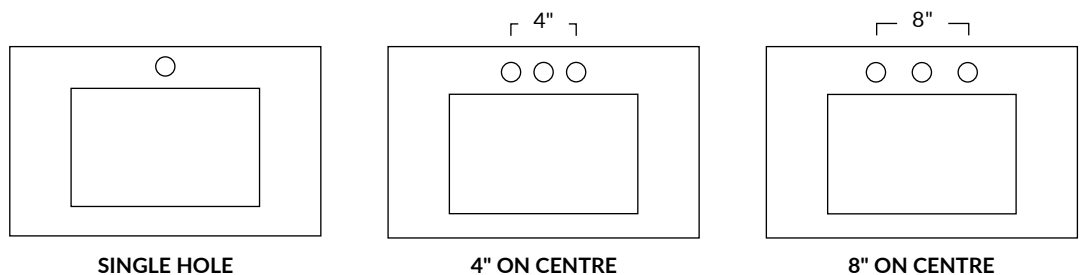

NOTE: Faucet holes are 1¾" diameter.



DOVER WHITE
Powder white that brings softness to any vanity



CARRERA
Crisp white top with marble inspired veining



WHITE SAND
White top with light grey quartz crystal flecks



GLACIER
White quartz with bold, dramatic veining pattern throughout

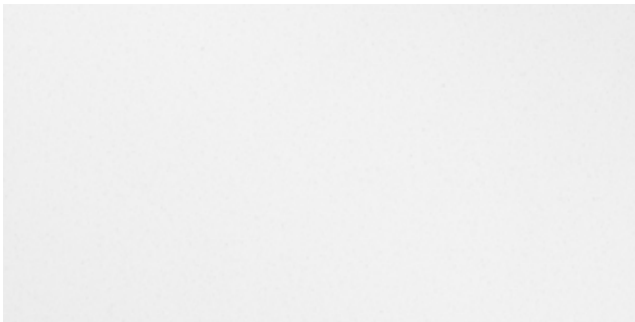

SUEDE
Bright and clean top that pairs perfectly with any base



LUNA
Warm grey with white and caramel veining complemented by light quartz sparkles on surface



FANTASY
Warm white stone with cool grey and light brown tones



MONACO
Warm white with light brown natural marble veining

NOTE: We do our best to accurately represent the true colour, tone, and grain pattern of our products in print form. There may be slight colour differences between these printed images, samples in store, and from product to product.



SEASIDE
Warm grey top with soft white veining



FUZION
Light grey background with rose undertones and multi-coloured quartz crystal surface



FROSTY GREY
Cool grey with frosted veining pattern of grey, white, and light brown tones



MOONSCAPE
Light and dark grey hues in an industrial textured pattern



NIAGARA MIST
Creamy taupe with white and brown veining

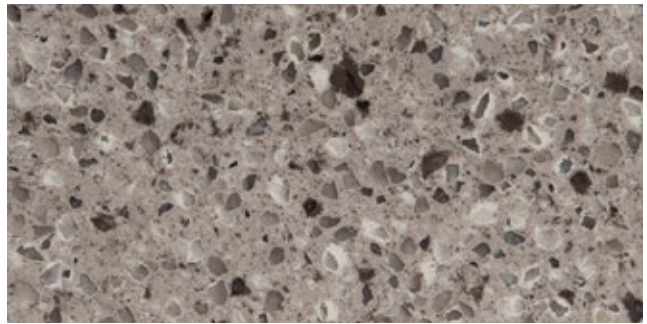

SIENNA
Tones of white, light, and dark grey stone pattern

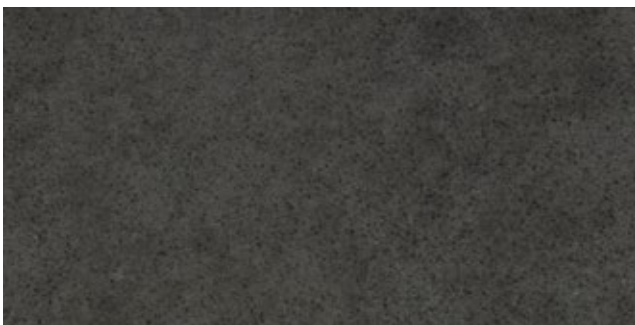

PEWTER
Dark grey with speckled surface pattern

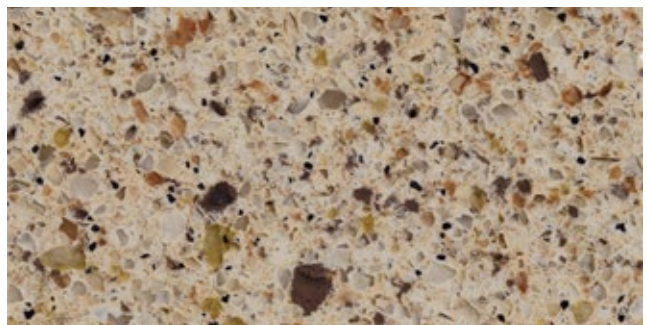

TERRA NOVA
Traditional European top with rusty hue pebble features

NOTE: We do our best to accurately represent the true colour, tone, and grain pattern of our products in print form. There may be slight colour differences between these printed images, samples in store, and from product to product.

UNDERMOUNT SINKS by akwa



CLASSIC

Distinguished by a deep elongated basin, the Classic sink is a traditional style. The wide-shaped, sweeping sides rest under the counter. Available in White or Linen*.



MANHATTAN

With unique vertical sides, a low sloping bottom, and a centre drain location, the Manhattan sink brings a more modern look to any vanity combination. Available in White or Linen*.



*The colour Linen is comparable to Kohler "Biscuit", Eljer "Silk", Toto "Sedona Beige", and American Standard "Linen".

24" VANITY TOP

This white porcelain top comes with an integrated rectangular sink and a sleek, modern profile. It features an overflow drain and non-porous glaze that prevents discolouration and fading. The wide, flat border around the basin provides practical storage.

Only available with single hole faucet drill pattern.

Dimensions: 24 $\frac{1}{4}$ " x 18 $\frac{1}{2}$ "



24" Espresso (Shaker) vanity with One-Piece Porcelain top



54" Dawn (Bellrose) vanity with Glacier quartz top and Brushed Nickel Bevelled handles



48" Desert Oak (Bellrose) vanity with Fantasy quartz top and Brushed Nickel Bar handles

ACCESSORIES

Complete the look of your new bathroom with a matching mirror, bath storage cabinet, or medicine cabinet. Accessories are available in all cabinetry finishes.

NOTE: Mirror colour matching applies to wood frames only.



BATH STORAGE CABINETS

Add a matching bath storage cabinet over your toilet for even more storage. Includes one adjustable interior wooden shelf.



30" MEDICINE CABINETS

30" medicine cabinets come right hinged with two adjustable glass shelves. They are designed to be mounted flush or recessed. To facilitate recessed installation we cut the back of the crown molding.

NOTE: Wall opening requirement for 30" recessed medicine cabinet is 35" x 25½".

48" MEDICINE CABINETS

48" medicine cabinets are designed to be mounted flush on a wall. They have two finished interior cabinets, each with three adjustable glass shelves.

Add an extra source of light!

48" medicine cabinets are available with three high efficiency, 3W LED flush mount lights for a secondary source of light. The lights are a soft white (3,000 K).

NOTE: 48" medicine cabinets do not fit between two linen towers on E layouts.



NEW!

36" x 36" Black Square mirror



Brushed Nickel metal mirror

METAL MIRRORS

Modernize the look of your bathroom with one of our metal framed mirrors! Banded by a 2mm thick, 1/4" wide stainless steel frame, this sleek design is available in either a Brushed Nickel or painted Black finish. Two pre-mounted French cleats on the back of the mirror are provided for installation.

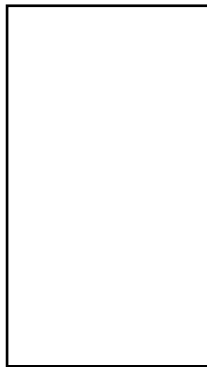
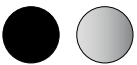

24" x 40"

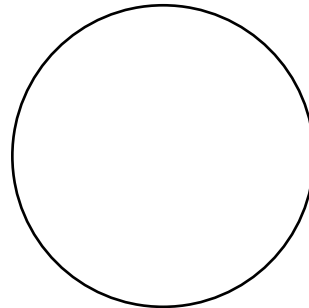

36" dia.

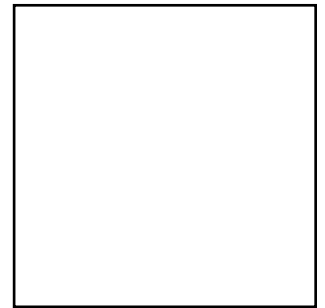

36" x 36"

NOTE: Due to the weight of these mirrors we **HIGHLY** recommend a skilled trades professional perform the final install.



26" Brown Oak mirror

WOOD MIRRORS

Complement your new vanity with a matching, wood-framed mirror. All mirrors are 35 5/8" in height and available in all cabinetry finishes.

Available mirror widths:
19 5/8", 26", 36", and 55 5/8"

DIMENSIONS

The following measurements are provided to help with the ordering process.
Please allow for 1/8" (+/-) variance.

VANITIES

24" SINGLE SINK

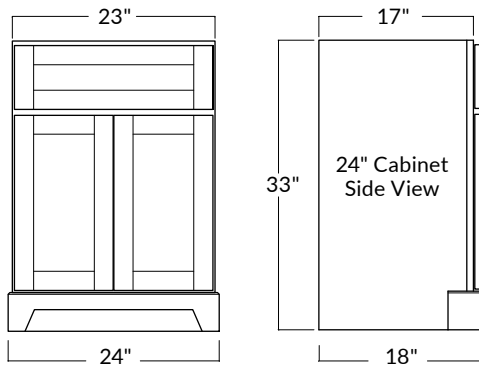

30" OR 36" SINGLE SINK DRESSER STYLE VANITY

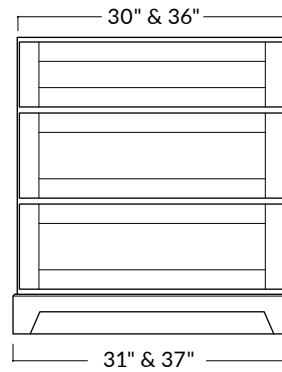

Upper drawer depth is 14" with 6" (w) x 9 1/4" (d) notch in centre to accommodate plumbing.

30" OR 36" SINGLE SINK (DRAWERS AVAILABLE ON LEFT OR RIGHT)

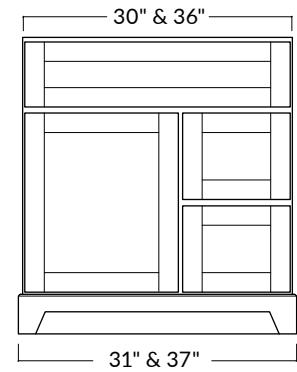

42", 48", 54", OR 60" SINGLE SINK

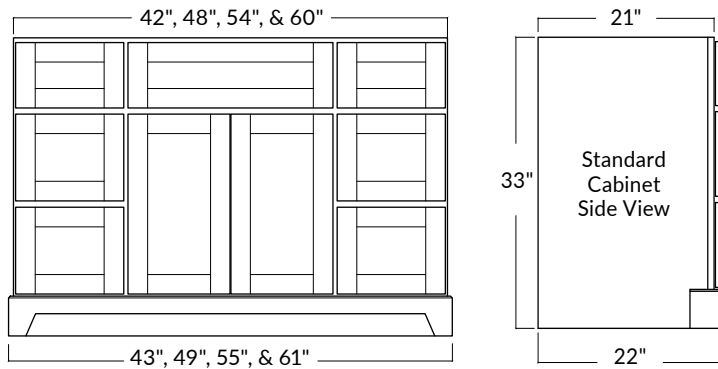

60" OR 72" DOUBLE SINK

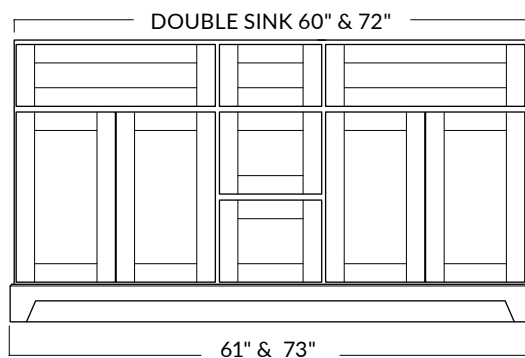

LINEN TOWER

Choose open shelves or an upper door with right or left hinge.

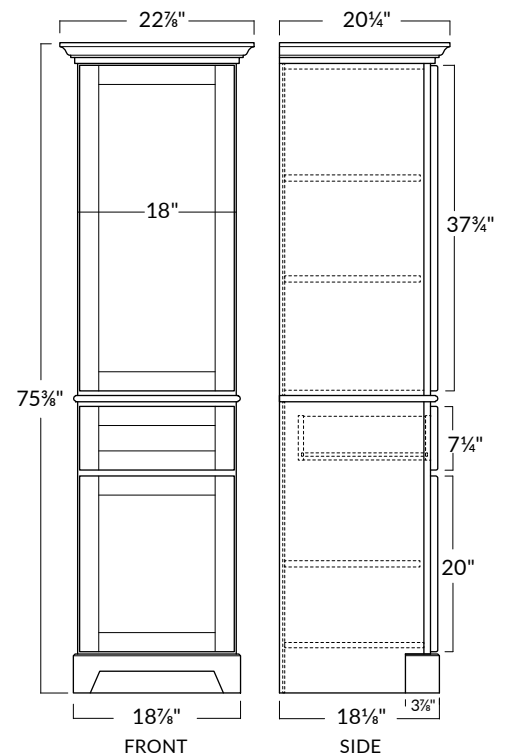

UNDERMOUNT SINKS

CLASSIC SINK PROFILE

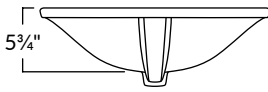

MANHATTAN SINK PROFILE

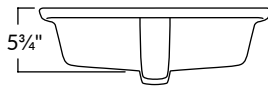

24" PORCELAIN TOP

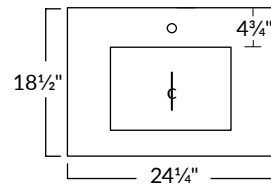

BASIN PROFILE

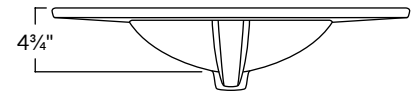

SINK POSITIONING WITH STONE TOPS (NOTE: The stone top opening for both the Classic and Manhattan Rectangular sink is 17" x 11 5/8")

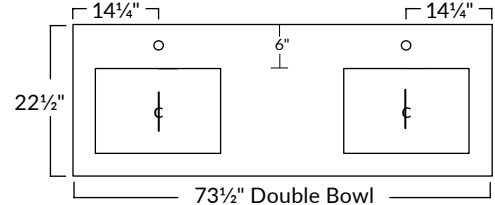
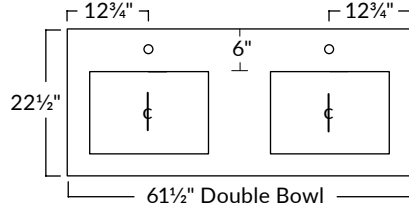
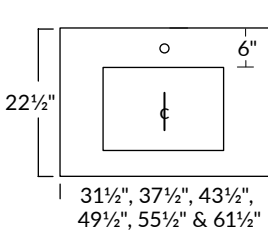

ACCESSORIES

METAL MIRRORS

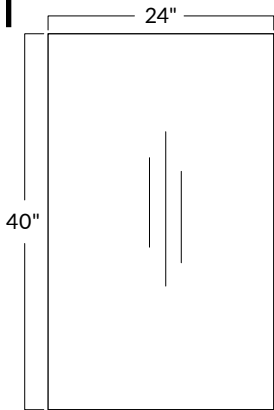

FRONT

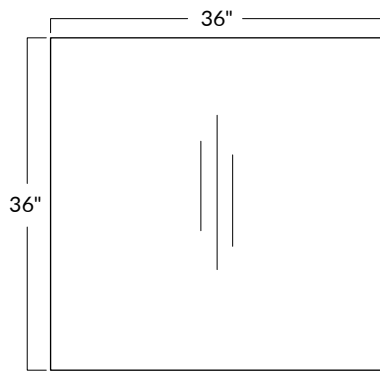

FRONT

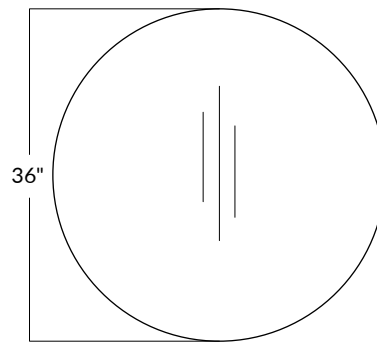

FRONT

WOOD MIRRORS

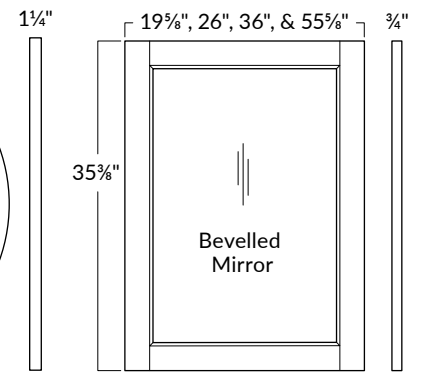

SIDE

FRONT

SIDE

BATH STORAGE CABINET

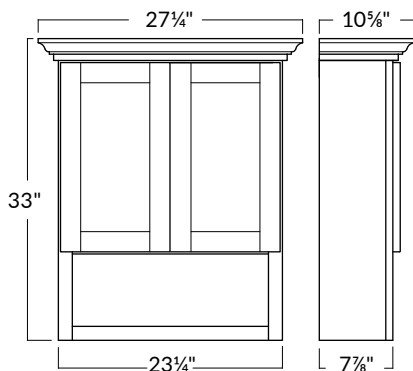

FRONT

SIDE

30" MEDICINE CABINET
(FLUSHED OR RECESSED)

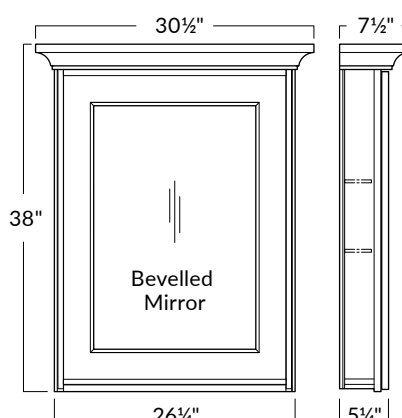

FRONT

SIDE

48" MEDICINE CABINET

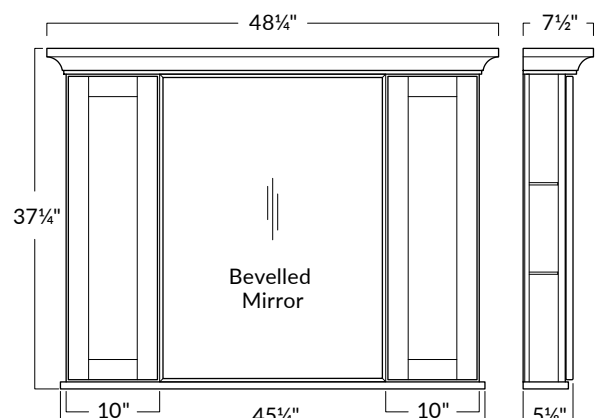

FRONT

SIDE

PROJECT PLANNING & INSTALLATION TIPS

We recommend having a **skilled trades professional** install your new bathroom furniture. Please refer to the planning tips below prior to installation.

INSTALLATION TIPS

As you design your new bathroom, the placement of your bathroom furniture and accessories are key for everyday functionality.

Here is a reference guide to help you with your placement measurements.

54" Smoke (Bellrose) vanity with Glacier quartz top, Chrome Bar handles, 36" mirror, and bath storage cabinet



PLANNING STEPS

1. Accurately measure your bathroom. Make note of plumbing locations, electrical outlets, light fixtures, and available wall depth at doorways.
2. Draw your bathroom to scale using provided dimensions (pg. 28-29) and layout options (pg. 31). NOTE: The stone vanity tops are 1½" wider than the width of the cabinet (¾" per side overhang).
3. Select your cabinet finish, hardware, stone vanity top, faucet drill pattern, sink, and accessories.
4. 1" colour-matched filler strips are included with the purchase of your vanity based on the layout option selected. 4" colour-matched filler strips are available at an additional charge.
5. Your vanity top comes complete with a matching 4" back-splash. Side splashes are included based on the layout option chosen. For an additional charge, vanity tops can be custom cut to fit between two walls. Please consult with a sales associate to help you fill out a custom cut vanity top order form.
6. Review and place your order with your dealer. Expect delivery within two - three weeks. Your dealer will have our delivery schedule.

LAYOUT OPTIONS

1

Between
two walls

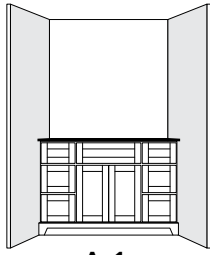

A-1

2

Wall on right,
open left

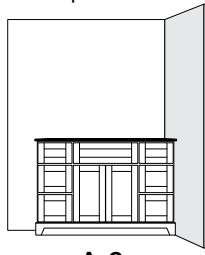

A-2

3

Wall on left,
open right

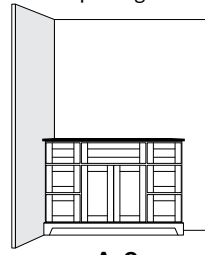

A-3

4

Free
standing

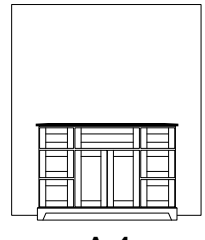

A-4

A

Vanity only

B

Vanity with
Linen Tower
(left)

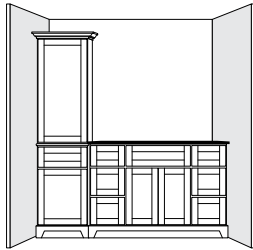

B-1

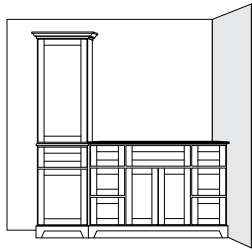

B-2

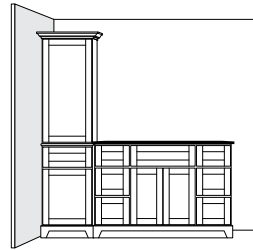

B-3

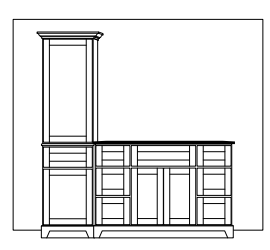

B-4

C

Vanity with
Linen Tower
(right)

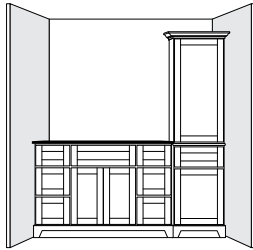

C-1

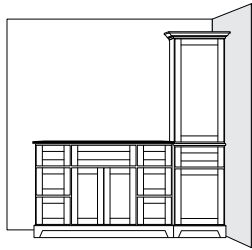

C-2

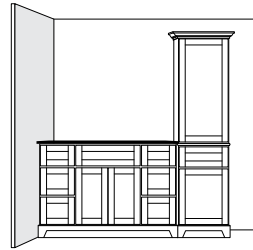

C-3

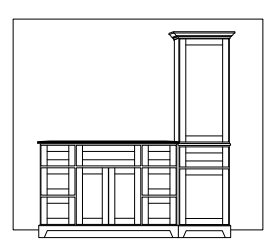

C-4

D

Double Vanity
with
Linen Tower
(centred)

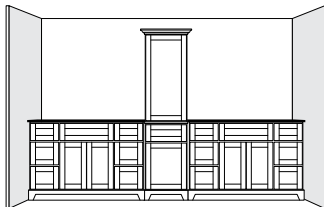

D-1

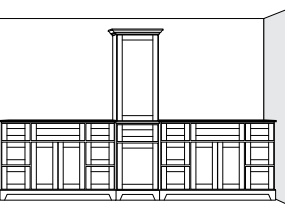

D-2

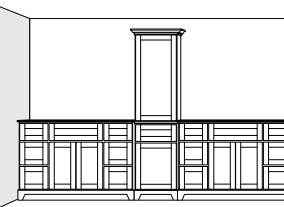

D-3

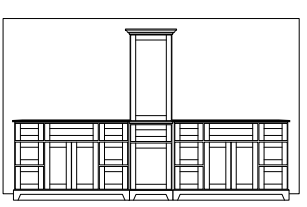

D-4

E

Vanity with
Linen Towers

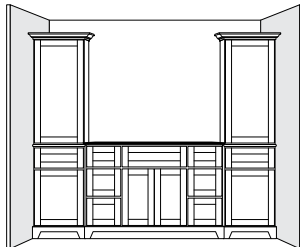

E-1

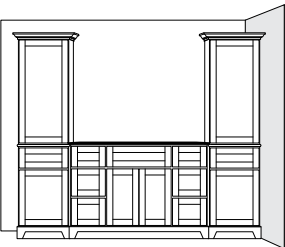

E-2

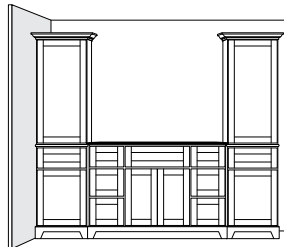

E-3

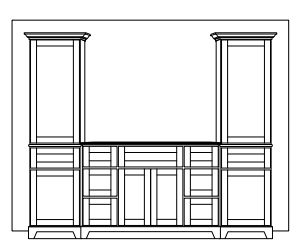

E-4

F

Linen Tower
Only

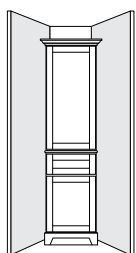

F-1

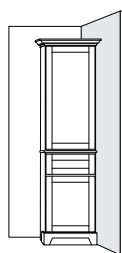

F-2

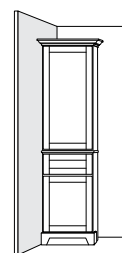

F-3

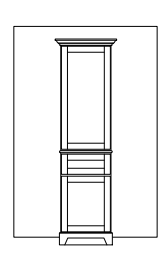

F-4

EASY ORDERING

Follow the steps below to order your new vanity exactly the way you want it.

1. CHOOSE YOUR VANITY SIZE AND FINISH



2. CHOOSE YOUR HARDWARE



3. CHOOSE YOUR STONE VANITY TOP



4. CHOOSE YOUR FAUCET DRILL PATTERN

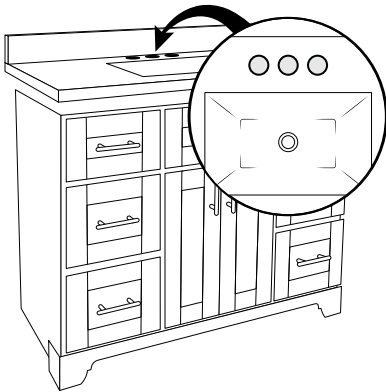

5. CHOOSE YOUR SINK



6. CHOOSE YOUR ACCESSORIES

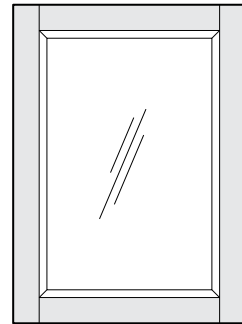

7. SPEAK TO YOUR SALES ASSOCIATE TO FINALIZE YOUR ORDER. EXPECT DELIVERY IN TWO - THREE WEEKS.

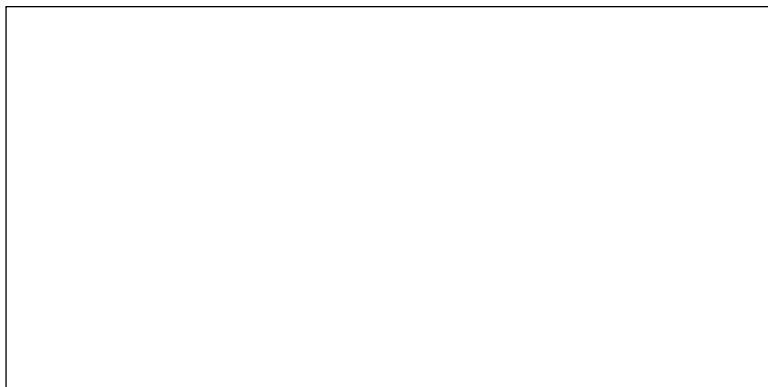

STONEWOOD
BATH CABINETS



stonewoodbath.com



Printed on 30% recycled material.
Please recycle.