

Features

- 33" (838 mm) minimum base cabinet width.
- Double-equal bowls.
- 9" (229 mm) depth provides generous workspace.
- Single faucet hole.
- Rear drain increases workspace in the sink and storage space underneath.
- Includes cutout template.

Material

- KOHLER® enameled cast iron.

Installation

- Top-mount.

Recommended Products/Accessories

- K-6121 Left-Bowl Sink Rack
- K-6122 Right-Bowl Sink Rack
- K-8801 Sink drain and strainer with tailpiece
- K-8799 Sink drain and strainer basket
- K-23726 Drain treatment
- K-23725 Cast iron cleaner

Optional Products/Accessories

- K-6545 Sponge Caddy
- K-11352 Disposal Flange with Stopper
- K-9000 P-Trap



Codes/Standards







ASME A112.19.1/CSA B45.2

KOHLER® Enameled Cast Iron Kitchen Sink Lifetime Limited Warranty

See website for detailed warranty information.

Available Colors/Finishes

Color tiles intended for reference only.

Color	Code	Description
	0	White
	FF	Sea Salt™
	96	Biscuit
	FD	Cane Sugar™
	K4	Cashmere
	7	Black Black™

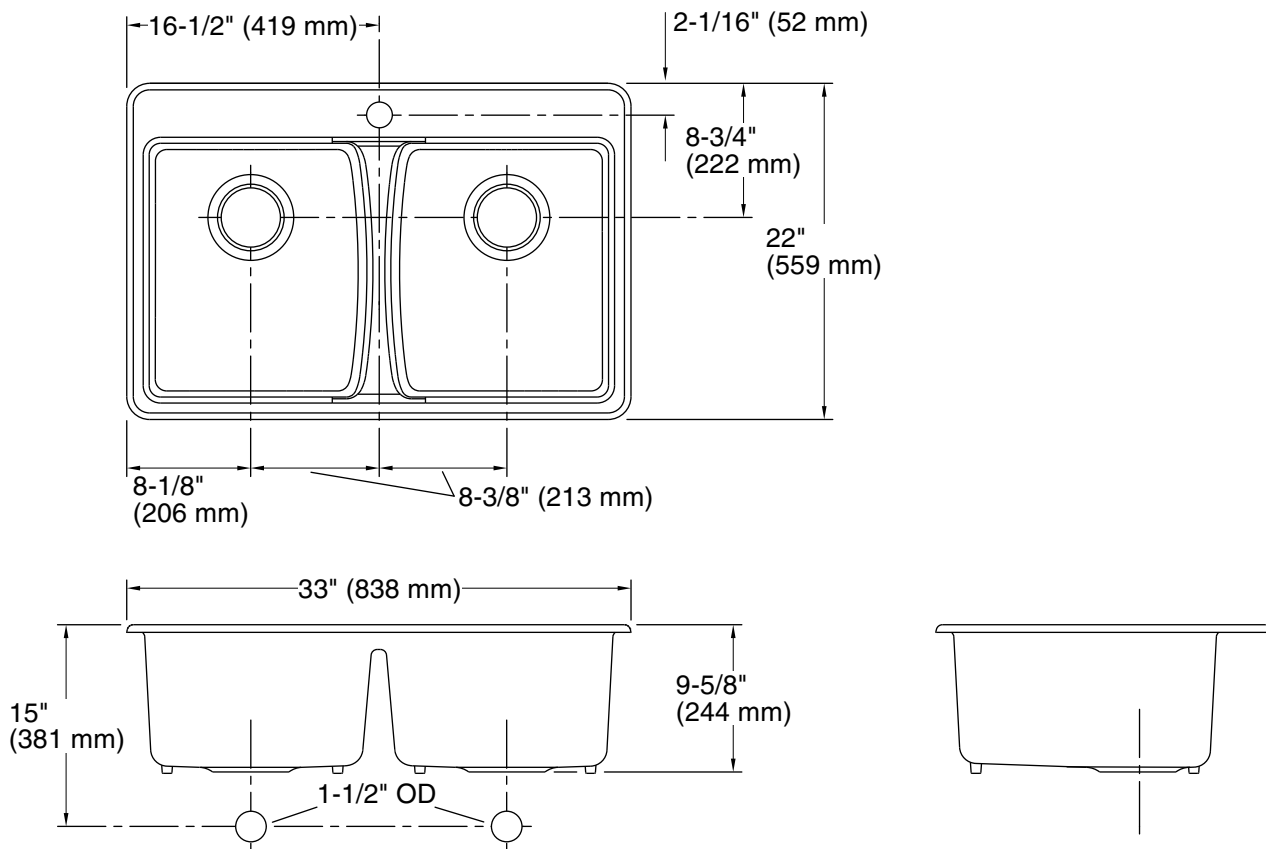

Technical Information

All product dimensions are nominal.

Bowl configuration:	Double equal
Installation:	Top-mount
Min. base cabinet width:	33" (838 mm)
Bowl area (Left):	Length: 14-1/4" (362 mm) Width: 16-9/16" (421 mm) Bowl depth: 9" (229 mm)
Bowl area (Right):	Length: 14-1/4" (362 mm) Width: 16-9/16" (421 mm) Bowl depth: 9" (229 mm)
Number of deck holes:	1
Faucet hole(s):	1-3/8" (35 mm)
Drain hole:	3-7/8" (98 mm)
Template:	1171757-7, required, included

Notes

Install this product according to the installation instructions.

NOTICE: Countertop manufacturer or cutter must use the cutout template provided with the product, or a current one provided by Kohler Co. (call 1-800-4-KOHLER). Kohler Co. is not responsible for cutout errors when the incorrect cutout template is used.