

Features

- Low-threshold design for easy entry and exit
- Covered drain with removable cover
- Single threshold for alcove installation
- Coordinates with other products in the Archer collection

Material

- Acrylic

Installation

- Center drain

Recommended Products/Accessories

- K-9132 Shower Drain
- K-706009-D3 Frameless Sliding Shower Door
- K-706009-L Frameless Sliding Shower Door
- K-706015-D3 Frameless Sliding Shower Door
- K-706015-L 74" H sliding shower door with 1/4"-thick glass
- K-23726 Drain treatment



Codes/Standards







- ASME A112.19.1/CSA B45.2
- CSA B45.5/IAPMO Z124
- ASTM E162
- ASTM E662

KOHLER® Plastic Baths and Shower Bases Lifetime Limited Warranty

See website for detailed warranty information.

Available Colors/Finishes

Color tiles intended for reference only.

| Color | Code | Description |
|---|------|---------------|
|  | 0 | White |
|  | 96 | Biscuit |
|  | NY | Dune |
|  | 95 | Ice™ Grey |
|  | 58 | Thunder™ Grey |
|  | 7 | Black Black™ |

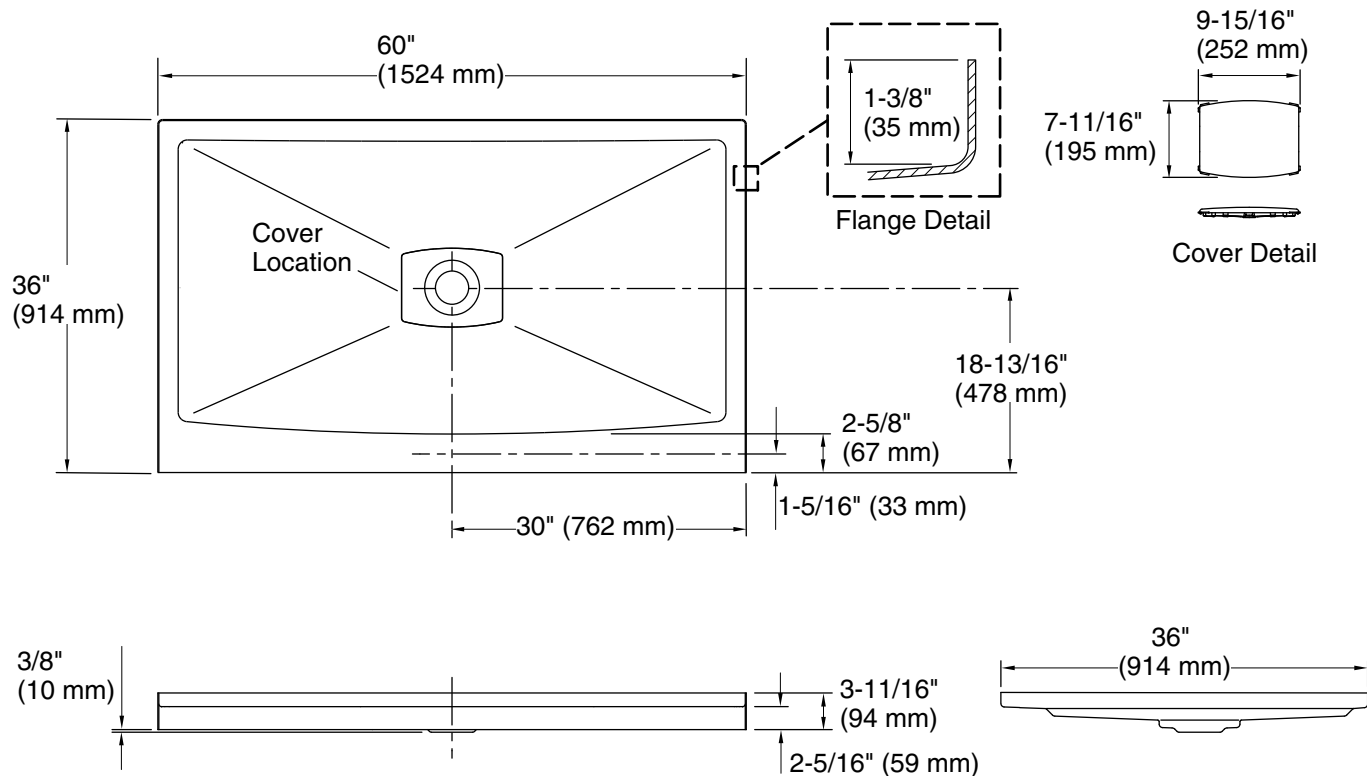

Technical Information

All product dimensions are nominal.

| | |
|------------------------|--|
| Drain location: | Center |
| Weight: | 52 lbs (23.6 kg) |
| Minimum floor load: | 17 lbs/ft ² (83 kg/m ²) |
| Minimum flat for door: | 2-5/8" (66 mm) |

Notes

Measure your actual product for rough-in details.

Install this product according to the installation instructions.

Shimming may be required to level the fixture.

Shimming may be required between the stud frame and the fixture.

Stud opening tolerance is + 1/4" (6 mm), - 0" (0 mm).