

AXOR Edge
Thermostatic Trim with Volume Control and Diverter - Diamond Cut
 Finishes : **chrome** Part no. : **46761001**



Features

- Volume control and diverter for 2 outlets
- Flow: 5.81 GPM (22 L/Min)
- Thermostatic cartridge, Shut-off/ diverter valve
- Anti-scald 100° safety stop

Item details

List Price \$ 2,151.00

Compliance

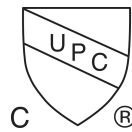

Product image



Scale drawing

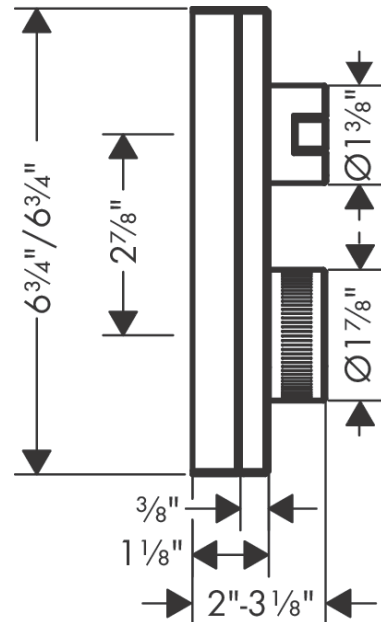

AXOR Edge
Thermostatic Trim with Volume Control and Diverter - Diamond Cut
Finishes : **chrome** Part no. : **46761001**



Exploded drawing

Year of production: >01/20

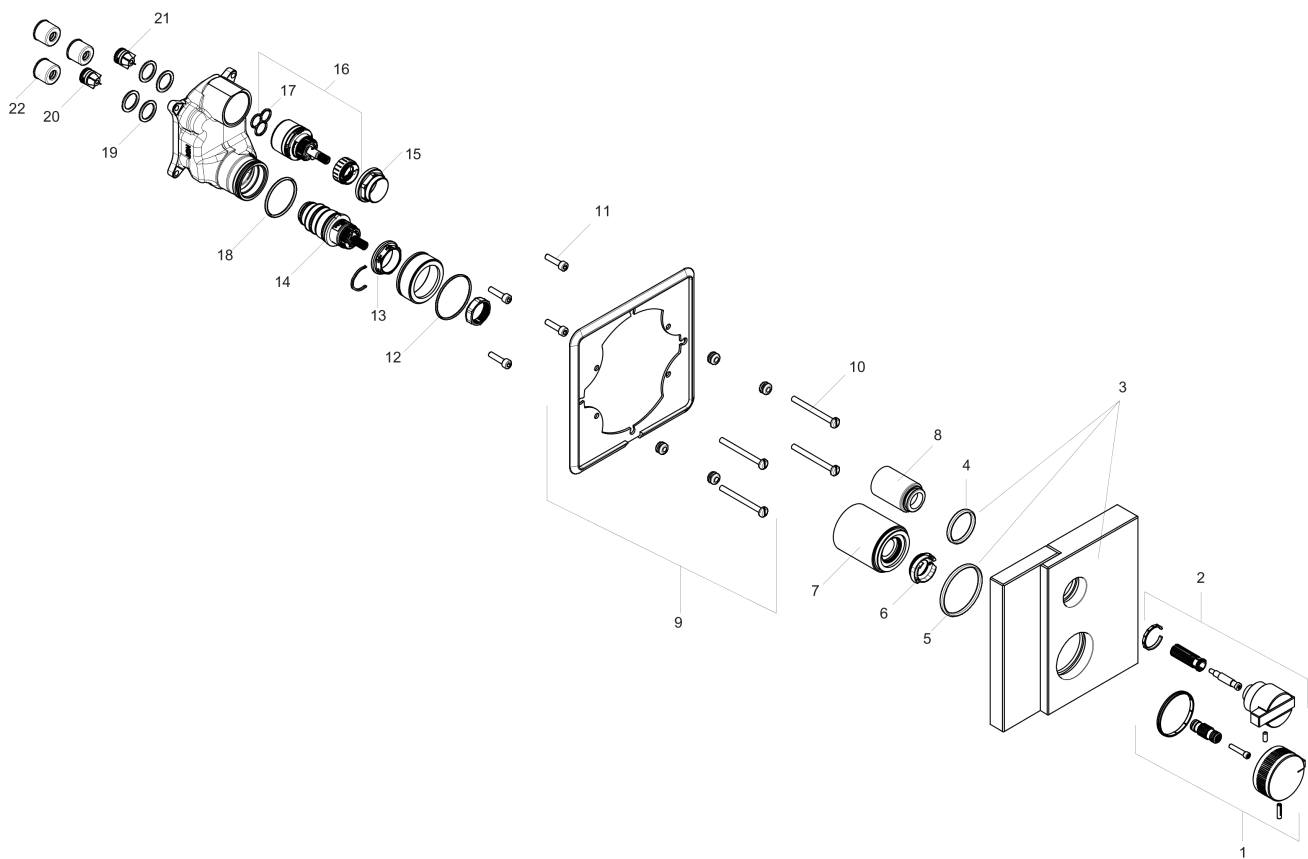

AXOR Edge

Thermostatic Trim with Volume Control and Diverter - Diamond Cut

Finishes : **chrome** Part no. : **46761001**



Spare parts list

Year of production: >01/20

Pos.		Part no.	Price	PU
1	handle for thermostat	93593001	-	1
2	handle	93762001	-	1
3	escutcheon 170 / 170 mm	93598000	-	1
4	O-ring 29x3	98371000	-	1
5	O-Ring 48x3	95508000	-	1
6	safety set	93603000	-	1
7	sleeve	93602000	-	1
8	sleeve	93601000	-	1
9	sub plate	93604000	-	1
10	set of fixing screws	96454000	-	1
11	set of screws	96525000	-	1
12	O-ring 43x1,5	98148000	-	1
13	nut	98913000	-	1
14	thermostat cartridge	98282000	-	1
15	nut	93605000	-	1
16	shut off unit with selector	98283000	-	1
17	seal	95008000	-	1
18	O-ring 36x2	98156000	-	1
19	O-ring 16x2	98133000	-	1
20	non return valve (pressure-resistant up to 2 MPa)	92594000	-	1
21	set of non return valves DW 15	94074000	-	1
22	noise reduction	94073000	-	1
a	cartridge for exchanged connections	92373000	-	1
b	extension 25 mm	13595000	-	1
c	set of fixing screws	97747000	-	1