

MODEL NUMBER:

☐ 1660.683 10" Modern Rain Showerhead only

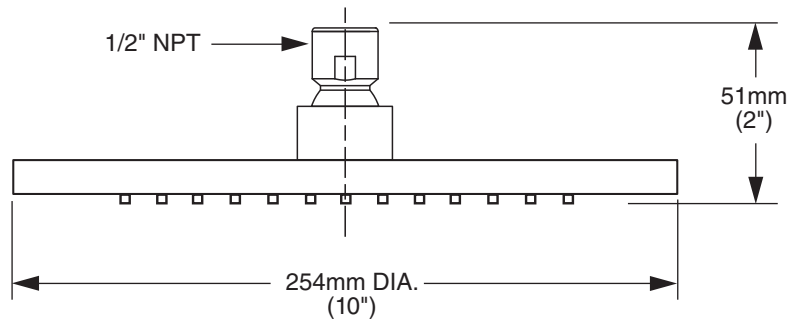

GENERAL DESCRIPTION:

8" rain showerhead. Brass construction. Drenching rain spray pattern. Includes pressure compensating flow control device. Brass ball joint. Easy clean spray nozzles. 1/2" NPT connection. 2.5gpm/9.5L/min. maximum flow rate.

PRODUCT FEATURES:

Drenching Rain Spray Pattern: Gives the user a drenching shower similar to a rain downpour.

Brass Construction: Durable. Easy to clean. Ideal for prolonged contact with water.

Pressure Compensating Flow Control Device: Provides consistent flow over a wide pressure range.

Easy Clean Spray Nozzles: Easily clean lime and calcium buildup. Nozzles will not clog.

SUGGESTED SPECIFICATION

Showerhead shall have rain spray pattern and brass ball joint. Showerhead shall have a pressure compensating control device. Fitting shall be American Standard Model # 1660.683.____.



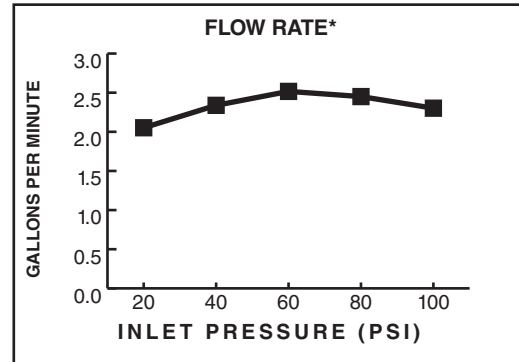

CODES AND STANDARDS

These products meet or exceed the following codes and standards:

**ASME A112.18.1
CSA 125.1**

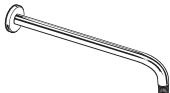

Product Number	Description	Finish Options	
		Polished Chrome	PVD Satin Nickel
		002	295
1660.683	10" Rain Showerhead Only		

Showerhead Accessories		
Product Number	Description	
1660.103	3" Ceiling Mount Shower Arm	
1660.186	6" Ceiling Mount Shower Arm	
1660.190	12" Ceiling Mount Shower Arm	
1660.194	12" Wall Mount Right Angle Shower Arm	
1660.118	18" Wall Mount Right Angle Shower Arm	
1660.191	Square Shower Arm Escutcheon	